



EVlink

Catalog April 2017

Electric vehicle charging solutions



schneider-electric.com/electric-vehicle

Life Is On

Schneider
Electric



Green Premium™

Endorsing the most eco-friendly products in the industry



Green Premium™ Product

Green Premium is the only label that allows you to effectively develop and promote an environmental policy whilst preserving your business efficiency. This ecolabel guarantees compliance with the most up-to-date environmental regulations, but it does more than this.

Over 75% of Schneider Electric manufactured products have been awarded the Green Premium ecolabel



Discover what we mean by green

Check your products!

Schneider Electric's Green Premium ecolabel is committed to offering transparency, by disclosing extensive and reliable information related to the environmental impact of its products:

RoHS

Schneider Electric products are subject to RoHS requirements at a worldwide level, even for the many products that are not required to comply with the terms of the regulation. Compliance certificates are available for products that fulfil the criteria of this European initiative, which aims to eliminate hazardous substances.

REACH

Schneider Electric applies the strict REACH regulation on its products at a worldwide level, and discloses extensive information concerning the presence of SVHC (Substances of Very High Concern) in all of these products.

PEP: Product Environmental Profile

Schneider Electric publishes the most complete set of environmental data, including carbon footprint and energy consumption data for each of the lifecycle phases on all of its products, in compliance with the ISO 14025 PEP ecopassport program. PEP is especially useful for monitoring, controlling, saving energy, and/or reducing carbon emissions.

EoLI: End of Life Instructions

Available at the click of a button, these instructions provide:

- Recyclability rates for Schneider Electric products.
- Guidance to mitigate personnel hazards during the dismantling of products and before recycling operations.
- Parts identification for recycling or for selective treatment, to mitigate environmental hazards/ incompatibility with standard recycling processes.

Contents

Presentation	
EVlink charging solutions: giving confidence in the future	p. 4
How it works	p. 7
The electric vehicle	p. 8
Where to charge	p. 9
Charging	p. 10
The EVlink product range	p. 13
9 selection criteria for charging station	p. 14
Communicating charging stations	p. 16
Overview of EVlink offer	p. 18
EVlink Wallbox	p. 20
EVlink Smart Wallbox	p. 26
EVlink Parking	p. 32
EVlink Fast Charge solution	p. 40
Electric vehicle simulation tool	p. 42
EVlink cable	p. 44
Managing charging station energy	p. 47
Energy management	p. 48
Cluster of charging stations supplied by the facility network	p. 50
Cluster of charging stations directly supplied by the utility grid	p. 51
Control of cluster of charging stations	p. 52
Solutions for your project	p. 55
Solutions for your project	p. 56
"Turnkey" project	p. 57
Services for contractors	p. 58
Services for operators	p. 59
List of references	p. 61

EVlink charging solutions:



Worldwide standards compliant



Worldwide customer support



Network of installation and service partners



* "from the well to the wheel — European mix" evaluation – Source: EDF 2010

giving confidence in the future



56,000 stations in 30 countries

“ Worldwide availability of our charging station and service offers is the best proof of our long-term engagement ”





Schneider
Electric

EVlink

How it works

The electric vehicle

4 major items:

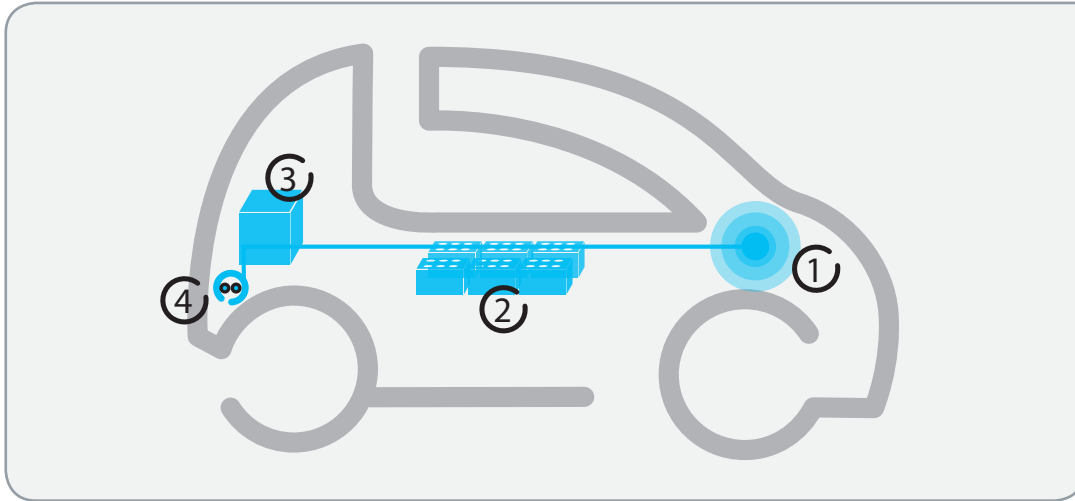

Focus on technology

The batteries

Battery technology has made very significant progress in recent years. Lead has gradually been replaced by other, more efficient compounds. Research continues with a view to improving capacity and reducing weight and heating during power inrush.

The most common technology at present is lithium-ion.

These new batteries have no memory effect and can therefore be charged without having to be completely empty. They are present in telephones, laptop computers, and some aircraft, as well as in electric vehicles.

① The motor

The vehicle has one or more motors. Depending on size and performance, the total power ranges between 15 and 200 kW.

Example: 48 kW (65 hp) for a small 4-seater sedan.

② The battery set

The battery set provides the energy necessary for the motor to operate. Charging takes place either during vehicle deceleration (motor in generator mode) or upon connection to a charging station.

The battery capacity is approximately 5 to 90 kWh at a voltage of 300 to 500 V.

Battery and distance range

The vehicle's distance range depends on battery capacity, as well driving style, road configuration, and use of accessories (headlights, heating, etc.).

③ The charger

The charger converts the alternating current from the charging station into direct current and limits the inrush current to the maximum acceptable by the cable + charging station combination.

④ The charging inlet

The vehicle is equipped by the manufacturer with one or two socket inlets, depending on the type of charging required:

- At least one inlet for "normal" or "accelerated" charging on the AC network.
- Possibly a second inlet for charging at a fast charging station.



Where to charge



At home

A charging station for private use installed in the garage.



At home — condominium

A charging station for indoor or outdoor use, installed in a private parking place.

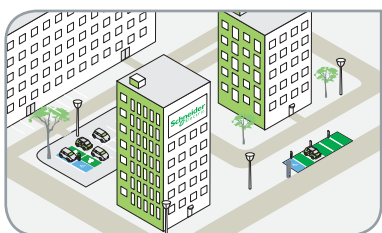

At work

More and more companies have installed charging stations in their own parking areas. They have a choice of whether users can charge their batteries for free or pay a fee.

Municipal fleets and the fleets of delivery services, and government departments generally have parking areas fully equipped to charge their electric vehicles.

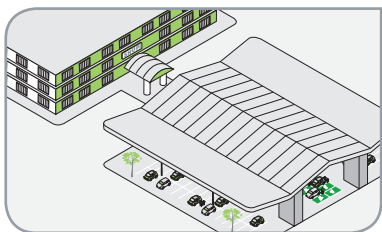

In private parking area

To meet new customer demands, the operators of covered public parking areas frequently offer charging stations. They can generally be accessed with a badge based on various commercial conditions.

Municipalities and car park managers are now developing these services.



On street

Involved in new green mobility deployment, municipalities are giving access to a network of charging stations located on the street or in public parking areas. Charging stations can generally be accessed with a badge or thanks to a Smartphone App., based on various commercial conditions.

Electric car sharing is another service offer that municipalities now promote. Charging station networks allow combined use by car-sharing services and electric vehicle drivers.

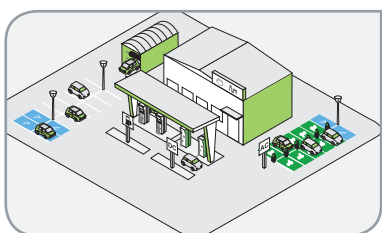

At service station

Service stations equipped for fast charging are appearing at test locations in some countries. Customers use the 30-minute charging time to take a break or shop in the supermarket.

Charging

> The charging mode determines the protection level

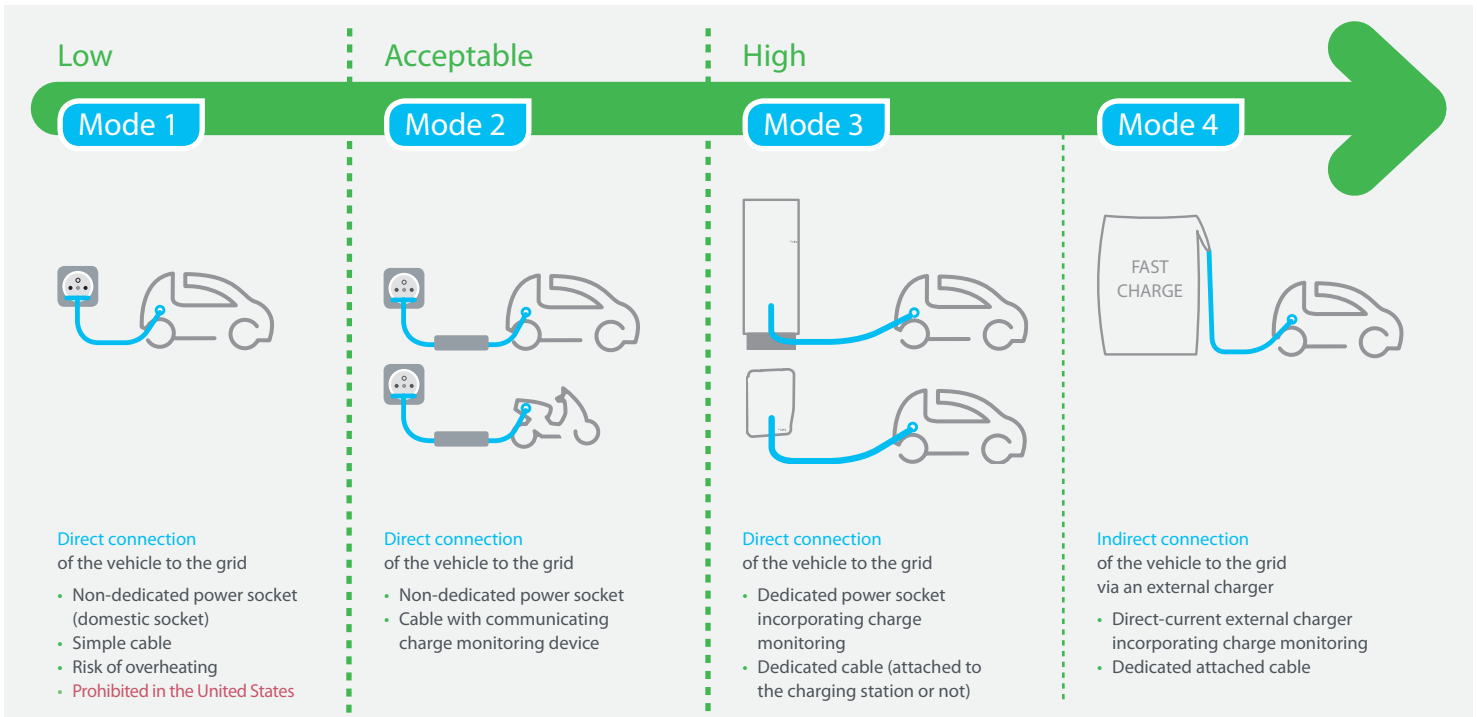

> Mode 2, Mode 3 or Mode 4 determines the type of charging connectors

Mode 2

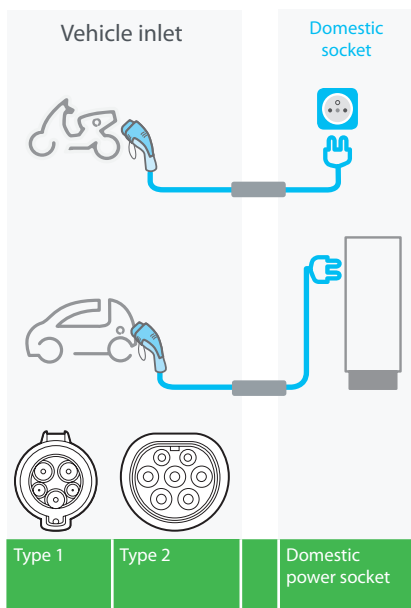

Mode 3

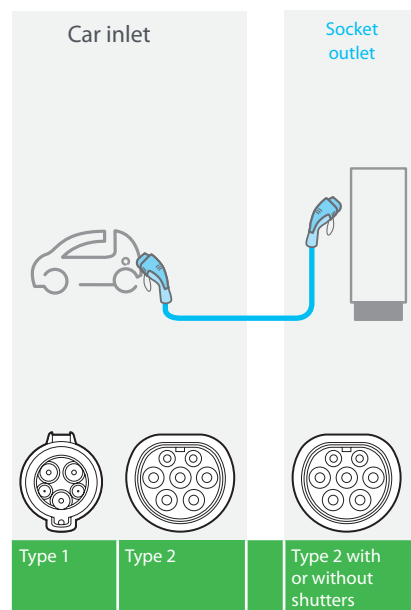

Mode 4

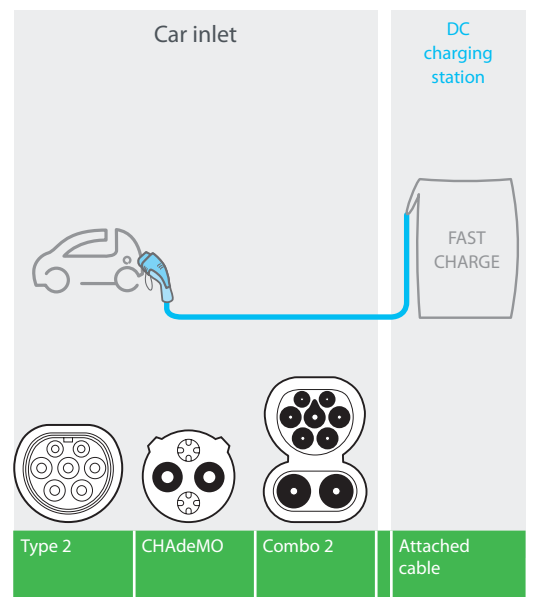

> The effective charging capacity is that of the weakest "link", for example:

Vehicle charger	Cable/charging mode	Charging point	Effective charging capacity
7 kW	2.3 kW (Mode 2)	Domestic power socket 2.3 kW (Mode 2)	2.3 kW
7 kW	7.4 kW (Mode 3)	Charging station 22.1 kW	7 kW

Focus on technology

The charging cable

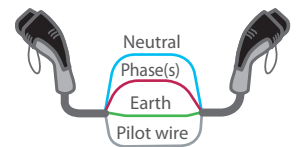

A "pilot" wire allows data communication between the vehicle and the charging station. The charging process starts only if the following information is OK:

- Vehicle connection
- Vehicle earthing
- Indication of the maximum power allowed by the charger

> The power of the source determines the charging speed*

Example: for a vehicle with a 24 kWh battery:

Source used	Domestic power socket	Dedicated AC power socket		Dedicated DC power socket
Power	Single-phase: 2.3 kW	Single-phase: 7.4 kW	Three-phase: 22.1 kW	Three-phase: 43 kW
Time to "fill up"	12 h	5 h	1h 30 min	30 min
% of charge reached in 30 min	4%	10%	34%	100%

* Subject to the use of a suitable cable.

Focus on technology

Electrical distribution architecture

Standalone

One or several charging stations can be connected to the same protection panel and operate independently. The protection could also be installed in the Parking station floor base (see chapter page 32). Each charging station operates independently. They are protected upstream and their consumption can be measured. The charging stations can be connected to a supervision.

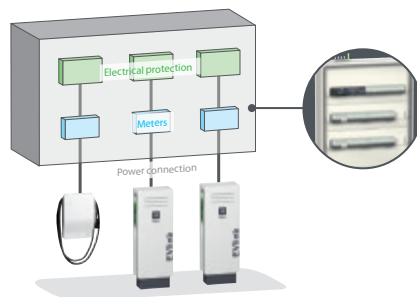

Clustered

In addition to independent charging stations features, benefit from advanced control functions:

EVlink energy management

They are then controlled by a programmable logic controller and network components, GPRS modem, etc. A cluster consists of charging stations, up to 24 socket outlets. The charging stations can be connected to a supervision.

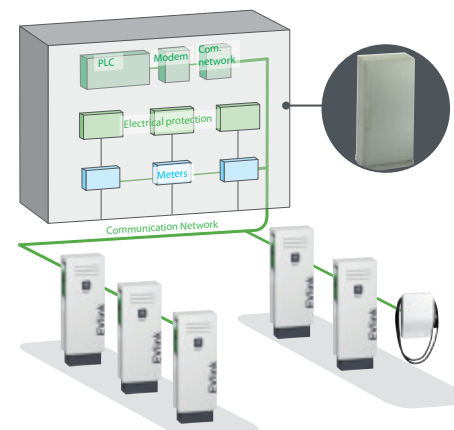



The EVlink product range

Electric vehicle charging stations

9 selection criteria for charging station

Electrical



Power per socket	3.7 kW - 7.4 kW ▲ Single-phase main supply.	11 kW - 22.1 kW ▲ Three-phase main supply.	22.1 kW - 43 kW (AC) - 50 kW (DC)
Charging mode	Mode 2 ▲ Use of charging cable equipped with its control interface.	Mode 3 ▲ Advanced charging control with communication between station and vehicle. Use of direct charging cable.	Mode 4 ▲ Advanced charging control with communication between station and vehicle for DC charging mode.
Socket outlet	Domestic ▲ Up to 2.3 kW	Type 2 ▲ Up to 22.1 kW	Attached cable type 1 Attached cable type 2 ▲ AC type 1: up to 7.4 kW ▲ AC type 2: up to 22.1 kW

Usage









Socket outlet access	Free access	Key ▲ Key lock.	Authentication ▲ Access with RFID badge or via Smartphone apps for connected stations. - Function depending whether connected station or not.
Energy management	Optimized cost ▲ The charging is delayed until cheapest tariff period, or reduced to comply with your contract.	Optimized time ▲ For not connected charging station. Fastest charge is achieved for each socket based on max. power of socket. Other functions available.	Advanced ▲ For a charging stations cluster connected to a facility network. A global energy management is provided (facility + stations) in order to preserve operational facility services building, site, etc. and to optimize vehicle charging.
Connectivity	Yes - No ▲ Enabling communication (wired, WiFi, GPRS modem) to the cloud-based supervision.		

Installation



Mounting	On Wall ▲ Cabinet fixed on wall.	On Floor ▲ Cabinet with integrated or separate pole.	
Protection	IP 54 ▲ Protection from dust, splashing water. Outdoor use is possible.	IP 55 ▲ Protection from dust, low pressure water jets. Outdoor use is possible.	IK 10 ▲ Resistance to pendulum shock: mass of 5 kg, 40 cm string.
Aspect	Stylish ▲ White resistant plastic casing.	Robust ▲ Metallic casing.	Robust + ▲ Antivandalism features. Metallic casing, extra keyboard protection.

	EVlink Wallbox	EVlink Smart Wallbox	EVlink Parking	EVlink Fast charge*																
<p>X Single characteristic</p> <p>X+Y Dual characteristic</p>																				
																				
Charging power (kW)	<table border="1"> <tr><td>3.7</td><td>7.4</td></tr> <tr><td>11</td><td>22.1</td></tr> </table>	3.7	7.4	11	22.1	<table border="1"> <tr><td>7.4</td><td>22.1</td></tr> </table>	7.4	22.1	<table border="1"> <tr><td>7.4</td><td>22.1</td></tr> </table>	7.4	22.1	<table border="1"> <tr><td>22.1 (AC)</td><td>43 (AC)</td><td>50 (DC)</td></tr> </table>	22.1 (AC)	43 (AC)	50 (DC)					
3.7	7.4																			
11	22.1																			
7.4	22.1																			
7.4	22.1																			
22.1 (AC)	43 (AC)	50 (DC)																		
Charging mode	<table border="1"> <tr><td>3</td></tr> </table>	3	<table border="1"> <tr><td>2</td><td>3</td></tr> </table>	2	3	<table border="1"> <tr><td>2</td><td>3</td></tr> </table>	2	3	<table border="1"> <tr><td>3</td><td>4</td></tr> </table>	3	4									
3																				
2	3																			
2	3																			
3	4																			
<table border="1"> <tr><td>2</td><td>Mode 2</td></tr> <tr><td>3</td><td>Mode 3</td></tr> <tr><td>4</td><td>Mode 4</td></tr> </table>	2	Mode 2	3	Mode 3	4	Mode 4														
2	Mode 2																			
3	Mode 3																			
4	Mode 4																			
Socket outlet Attached cable	<table border="1"> <tr><td>T2</td><td></td></tr> <tr><td>ACT1</td><td>ACT2</td></tr> </table>	T2		ACT1	ACT2	<table border="1"> <tr><td>T2</td><td>T2+D</td></tr> <tr><td>ACT1</td><td>ACT2</td></tr> </table>	T2	T2+D	ACT1	ACT2	<table border="1"> <tr><td>T2</td><td>T2+D</td></tr> <tr><td>T2+T2</td><td></td></tr> </table>	T2	T2+D	T2+T2		<table border="1"> <tr><td>ACChadeMo</td><td>ACCombo 2</td></tr> <tr><td>ACT2 43 kW (AC)</td><td></td></tr> </table>	ACChadeMo	ACCombo 2	ACT2 43 kW (AC)	
T2																				
ACT1	ACT2																			
T2	T2+D																			
ACT1	ACT2																			
T2	T2+D																			
T2+T2																				
ACChadeMo	ACCombo 2																			
ACT2 43 kW (AC)																				
<table border="1"> <tr><td>D</td><td>Domestic</td></tr> <tr><td>ACT1</td><td>Att. cable with plug Type 1</td></tr> <tr><td>ACT2</td><td>Att. cable with plug Type 2</td></tr> <tr><td>T2</td><td>Plug type 2</td></tr> </table>	D	Domestic	ACT1	Att. cable with plug Type 1	ACT2	Att. cable with plug Type 2	T2	Plug type 2												
D	Domestic																			
ACT1	Att. cable with plug Type 1																			
ACT2	Att. cable with plug Type 2																			
T2	Plug type 2																			
Charging access	<table border="1"> <tr><td>F</td><td>K</td></tr> </table>	F	K	<table border="1"> <tr><td>F</td><td>K</td></tr> <tr><td>A</td><td></td></tr> </table>	F	K	A		<table border="1"> <tr><td>F</td><td>A</td></tr> </table>	F	A	<table border="1"> <tr><td>F</td><td>A</td></tr> </table>	F	A						
F	K																			
F	K																			
A																				
F	A																			
F	A																			
<table border="1"> <tr><td>F</td><td>Free access</td></tr> <tr><td>K</td><td>Key lock</td></tr> <tr><td>A</td><td>Authentication</td></tr> </table>	F	Free access	K	Key lock	A	Authentication														
F	Free access																			
K	Key lock																			
A	Authentication																			
Energy management	<table border="1"> <tr><td>C</td></tr> </table>	C	<table border="1"> <tr><td>A+C+T</td></tr> </table>	A+C+T	<table border="1"> <tr><td>A+C+T</td></tr> </table>	A+C+T														
C																				
A+C+T																				
A+C+T																				
<table border="1"> <tr><td>A</td><td>Advanced</td></tr> <tr><td>C</td><td>Cost optimized</td></tr> <tr><td>T</td><td>Charging time optimized</td></tr> </table>	A	Advanced	C	Cost optimized	T	Charging time optimized														
A	Advanced																			
C	Cost optimized																			
T	Charging time optimized																			
Connectivity	<table border="1"> <tr><td>N</td></tr> </table>	N	<table border="1"> <tr><td>N</td><td>Y</td></tr> </table>	N	Y	<table border="1"> <tr><td>N</td><td>Y</td></tr> </table>	N	Y	<table border="1"> <tr><td>N</td><td>Y</td></tr> </table>	N	Y									
N																				
N	Y																			
N	Y																			
N	Y																			
<table border="1"> <tr><td>Y</td><td>Yes (ready to connectivity)</td></tr> <tr><td>N</td><td>No</td></tr> </table>	Y	Yes (ready to connectivity)	N	No																
Y	Yes (ready to connectivity)																			
N	No																			
Mounting	<table border="1"> <tr><td>W</td><td>F</td></tr> </table>	W	F	<table border="1"> <tr><td>W</td><td>F</td></tr> </table>	W	F	<table border="1"> <tr><td>W</td><td>F</td></tr> </table>	W	F	<table border="1"> <tr><td>F</td></tr> </table>	F									
W	F																			
W	F																			
W	F																			
F																				
<table border="1"> <tr><td>W</td><td>Wall</td></tr> <tr><td>F</td><td>Floor</td></tr> </table>	W	Wall	F	Floor																
W	Wall																			
F	Floor																			
Protection	<table border="1"> <tr><td>IP</td><td>54</td></tr> <tr><td>IK</td><td>10</td></tr> </table>	IP	54	IK	10	<table border="1"> <tr><td>54</td><td>55</td></tr> <tr><td>10</td><td>10</td></tr> </table>	54	55	10	10	<table border="1"> <tr><td>54</td><td></td></tr> <tr><td>10</td><td></td></tr> </table>	54		10		<table border="1"> <tr><td>55</td><td></td></tr> <tr><td>10</td><td></td></tr> </table>	55		10	
IP	54																			
IK	10																			
54	55																			
10	10																			
54																				
10																				
55																				
10																				
<table border="1"> <tr><td>54</td><td>Dust + splashing water</td></tr> <tr><td>55</td><td>Dust + low pressure water jet</td></tr> <tr><td>10</td><td>5 kg shock</td></tr> </table>	54	Dust + splashing water	55	Dust + low pressure water jet	10	5 kg shock														
54	Dust + splashing water																			
55	Dust + low pressure water jet																			
10	5 kg shock																			
Aspect	<table border="1"> <tr><td>S</td></tr> </table>	S	<table border="1"> <tr><td>S</td></tr> </table>	S	<table border="1"> <tr><td>R</td></tr> </table>	R	<table border="1"> <tr><td>R+</td></tr> </table>	R+												
S																				
S																				
R																				
R+																				
<table border="1"> <tr><td>S</td><td>Stylish</td></tr> <tr><td>R</td><td>Robust</td></tr> <tr><td>R+</td><td>Robust +</td></tr> </table>	S	Stylish	R	Robust	R+	Robust +														
S	Stylish																			
R	Robust																			
R+	Robust +																			

* Offer limited to selected countries with project management mode.

Communicating charging stations

Charging station connectivity

EVlink Parking and EVlink Smart Wallbox charging stations are fitted with Ethernet ports (cable). EVlink Smart Wallbox can be equipped with an additional WiFi module for connection to a wireless LAN (no direct WiFi between PC and charging station).

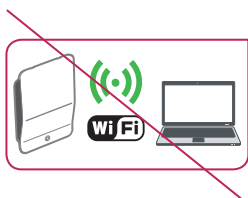
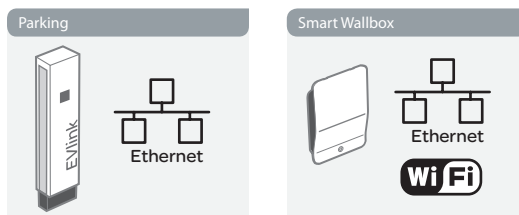

Communication for commissioning purpose

Charging stations settings are customized during the commissioning phase. Their Ethernet port must be connected to a standard PC for this purpose. No WiFi connection available at this stage.

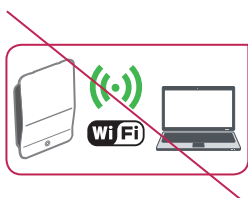
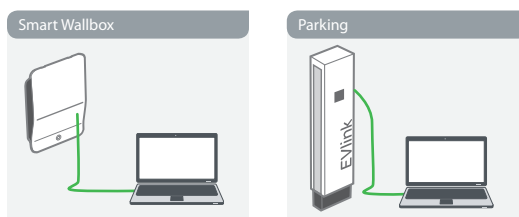

Communication for maintenance purpose

Later changes of charging stations settings are sometime requested. They can be achieved by either:

- direct connection to charging station Ethernet port,
- or connection via a LAN, avoiding to open/close the charging station.

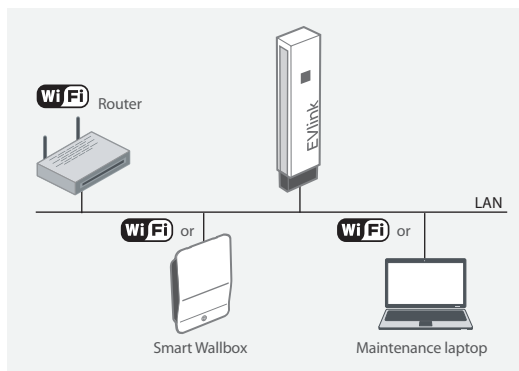
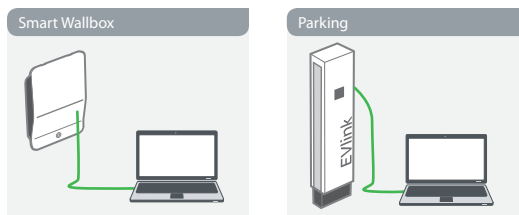



Communication for Cloud supervision

EVlink Parking and EVlink smart wallbox access to the Cloud is available with GPRS or DSL technologies, and OCPP protocol.

Available Supervision services:

- User Access Management
- Getting Charge Details Records
- Reporting
- Asset management.

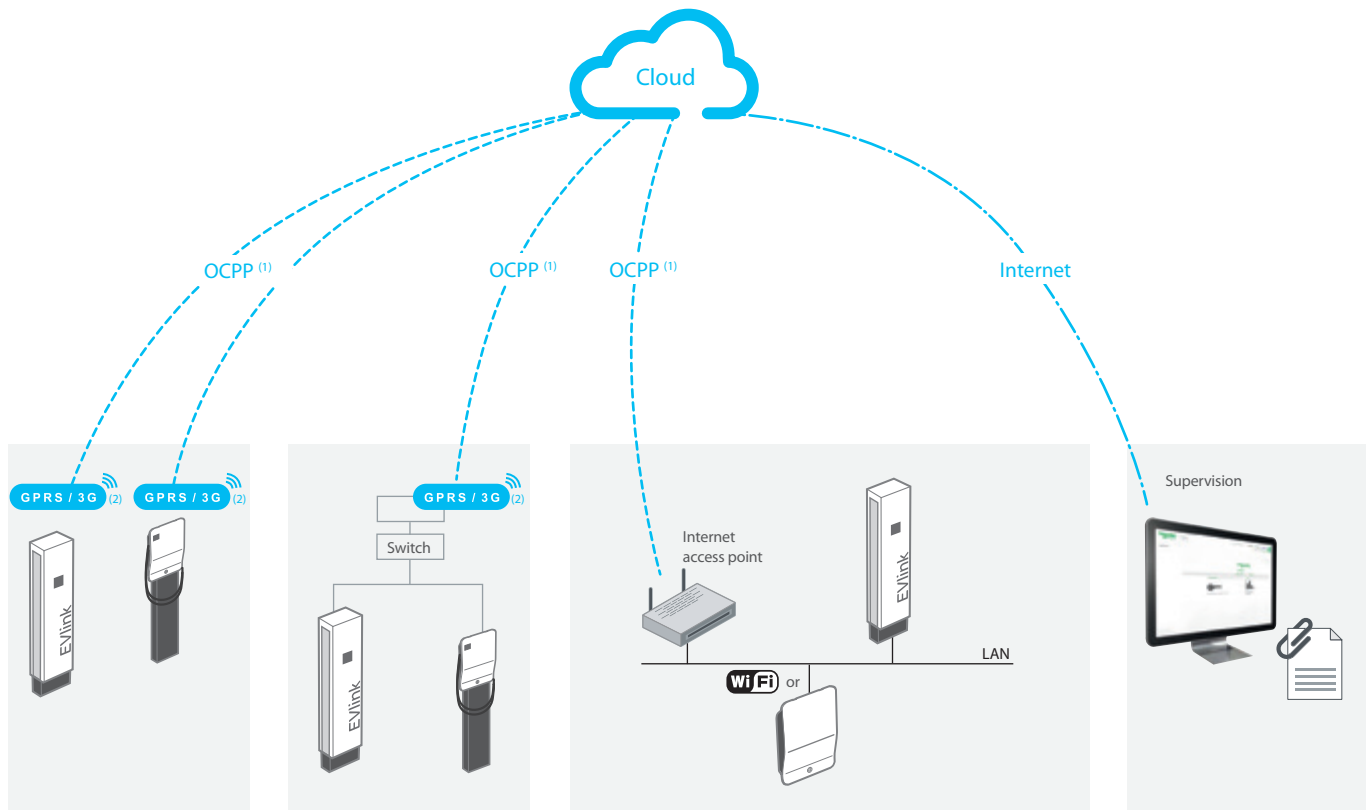

⁽¹⁾ OCPP: Open Charge Point Protocol standard

⁽²⁾ 3G modem: available september 2017

Overview of EVlink offer

EVlink Wallbox



page 20

- Outdoor or Indoor installation
- Wall-mounted or floor standing*
- Power Range: 3.7 kW to 22.1 kW with permanent derating option
- Socket outlet (T2/T2S) or attached cable (T2/T1)
- Keylock to limit socket outlet access and/or limit access while charging

* pole as an accessory

How to use an EVlink Wallbox



Scan or click on QR code

EVlink Smart Wallbox



page 26

- Outdoor or Indoor installation
- Wall-mounted or floor standing*
- Power Range: 7.4 kW or 22.1 kW with permanent derating option
- Socket outlet (T2/T2S) + domestic socket option (TE) or attached cable (T2/T1)
- Key lock to limit socket outlet access and/or limit access while charging
- RFID badge authentication
- Energy metering capacity
- Optional communication module (Wifi and/or GPRS/3G) or Ethernet to connect to a Supervision

* pole as an accessory

How to use an EVlink Smart Wallbox



Scan or click on QR code

EVlink Parking



page 32

- Outdoor or Indoor installation
- Wall-mounted or floor standing
- Power Range: 7.4 kW to 22.1 kW with permanent derating option
- 1 or 2 socket outlet (T2/T2S) + domestic socket option (TE)
- Free access or RFID badge authentication
- Energy metering capacity with automatic load balancing through commissioning
- Optional communication module (GPRS/3G) or Ethernet to connect to a Supervision

How to use an EVlink Parking charging station



Scan or click on QR code

Energy management, supervision

Energy, communication management functions

- Avoid facility disruptions
- Reduce energy cost
- Increase driver satisfaction
- Make operation more efficient



Enterprise-wise management, supervision*

- Usage analysis
- Remote maintenance
- Drivers management

* please contact us



EVlink Fast Charge solution*



page 40

- Outdoor or Indoor installation with vandalism resistant enclosure
- Floor Standing
- 1, 2 or 3 charge points Mode 3 and Mode 4 (one charge point in option)
- Max DC output power: 50 kW (on CHAdeMo and Combo 2 Type connector)
- Max AC output power: 22 kW and 43 kW (on Type 2 connector)
- Free access or RFID badge authentication

* Offer limited to selected countries with project management mode.



EVlink accessories & spare parts



- Floor standing and wall mounted bases
- Socket outlets, charging cables, cable holder
- Caps, covers
- Pack of 10 RFID badges
- Electric vehicle simulation tool
- Key lock
- GPRS/3G modem
- Wi-Fi card

EVlink Services



EVlink Services: Solutions for your projects

As an energy management specialist, Schneider Electric offers the following services:

- Installation audit and commissioning by trained engineers or certified installers
- Warranty extension (on standard 24 months warranty)
- Training of your staff
- Monitoring and connectivity of your infrastructure
- Maintenance contracts and assets management
- Spare parts offer for all EVlink charging stations.

EVlink Wallbox

In short



Product QR code
'FLASH ME'



Extensive choice

Range of 14 charging stations:

- Rated charging power: 3.7, 7.4, 11 or 22.1 kW
- T2 socket outlet (with or without shutter) or attached cable (with T1 or T2 connector)
- Heavy duty socket outlet with silver plated contacts avoiding overheating

Charging station QR Code

- To get the product datasheet or to join Customer Care Center with "mySchneider" app, flash the QR Code with your usual QR Code reader.
- To access cloud-based EcoStruxure™ Facility Expert app maintenance organizer: charging station registration, maintenance reports, (see page 25)

Robustness

- Highly robust to mechanical impact: IK10
- Suitable for outdoor use: IP54

Easy to use

- "Plug and charge"
- One-touch stop/restart
- Attached cable rolled up around the Wallbox
- 1 or 2 charging stations on the same pole
- Technical documentation: installation sheet and quick start guide in many languages (see "Additional information", page 25)

Selectable energy management function

- Delayed start allowing off-peak hours charging only or
- Temporary current limitation (from 16 A to 10 A or from 32 A to 16 A) protecting building users from blackouts.

Functions are activated by external contacts (off-peak contact, load-shedding module contact, etc.) hardwired on a station digital input.

At home



At home — condominium



In private parking area

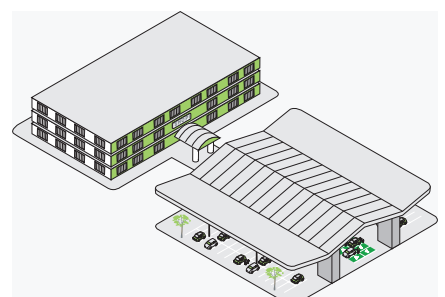

Application

Wallbox are recommended for homes, as well as tougher environments (condominium, corporate car park, hotel, etc.), because of their weatherproof and robust design.

Discovery

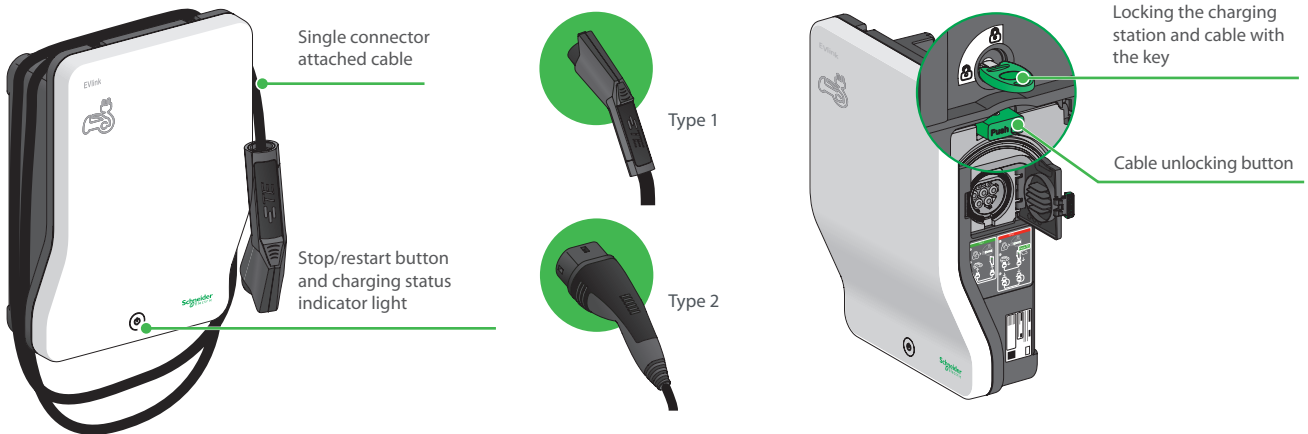

Charging station with attached cable

Charging station with socket outlet

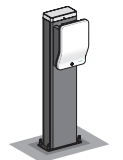

1 or 2 Wallbox on optional pedestal mounting pole



Charging station unlocked

- Locking the station with the key
- Impossible to insert the plug
 - Impossible to extract the cable
 - Impossible to stop/start charging



Charging station locked

Easy to install

Installation by a single technician in less than 30 minutes;
no special tools required
Top, bottom or back side wiring
Immediate commissioning

What's inside an EVlink Wallbox



Scan or click on QR code

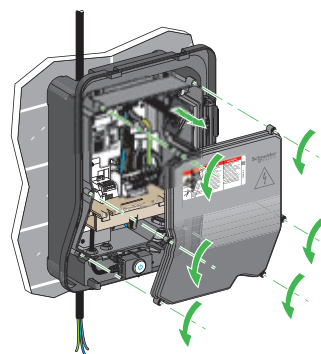
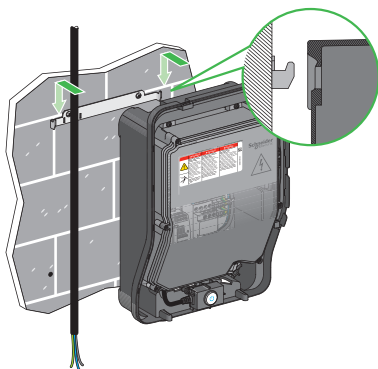

EVlink Wallbox

Characteristics



Power supply network

- 220 - 240 V single-phase – 50/60 Hz for 3.7 and 7.4 kW charging stations
- 380 - 415 V three-phase – 50/60 Hz for 11 and 22.1 kW charging stations
- Earthing diagrams:
 - TT, TN-S, TN-C-S
 - IT (may require the addition of an isolating transformer for charging of certain vehicles)

Mechanical and environmental characteristics

- Ingress protection code: IP54
- Impact protection code: IK10
- Operating temperature: -30°C to +50°C
- Storage temperature: -40°C to +80°C
- Attached cable length: 4 m
- Energy management: deferred charging start or charging current limitation (16 A to 10 A, 32 A to 16 A)

Charging access

- Free access
- By key lock, for socket outlet insertion and locking

Warranty

- 24 months for the entire EVlink range

Standards

- IEC/EN 61851-1 ed 2.0
- IEC/EN 61851-22 ed 1.0
- IEC/EN 62196-1 ed 2.0
- IEC/EN 62196-2 ed 1.0



Z.E. READY



> ROHS compliant
> Reach compliant
> EoLi: End Of Life Process
> Product Environmental Profile compliant

Certification

EVlink Wallbox has obtained the CB test certificate issued by the LCIE test laboratory, establishing compliance with the IEC 61851-1 and IEC 61851-22 standards.

Charging station references

> EVlink Wallbox



Description	Socket outlet or connector type	Power (kW) Phases	References
With socket outlet on right side⁽¹⁾ - Silver-plated contacts			
T2		3.7 (1P - 16 A)	EVH2S3P02K ⁽²⁾
		7.4 (1P - 32 A)	EVH2S7P02K ⁽²⁾
		11 (3P - 16 A)	EVH2S11P02K
		22.1 (3P - 32 A)	EVH2S22P02K
T2 with shutters		3.7 (1P - 16 A)	EVH2S3P04K ⁽²⁾
		7.4 (1P - 32 A)	EVH2S7P04K ⁽²⁾
		11 (3P - 16 A)	EVH2S11P04K ⁽²⁾
		22.1 (3P - 32 A)	EVH2S22P04K ⁽²⁾
With attached cable 4 m, on right side - Silver-plated contacts			
T1		3.7 (1P - 16 A)	EVH2S3P0AK
		7.4 (1P - 32 A)	EVH2S7P0AK
T2		3.7 (1P - 16 A)	EVH2S3P0CK ⁽²⁾
		7.4 (1P - 32 A)	EVH2S7P0CK ⁽²⁾
		11 (3P - 16 A)	EVH2S11P0CK
		22.1 (3P - 32 A)	EVH2S22P0CK

⁽¹⁾ Cable available as an accessory.

⁽²⁾ Shorter delivery time.

> Protective devices and optional equipment

Description	Single-phase		Three-phase	
Charging				
Rated Power - Current	3.7 kW - 16 A	7.4 kW - 32 A	11 kW - 16 A	22.1 kW - 32 A
Protection				
Circuit breaker (overcurrent) ⁽¹⁾	20 A Curve C	40 A Curve C	20 A Curve C	40 A Curve C
RCD (residual-current) ⁽¹⁾	30 mA type As ⁽²⁾		30 mA type B	
Under voltage tripping auxiliary	A9N26969 (optional)	A9N26969	A9N26969	A9N26969
Deferred start				
Relay	With normally open contact			
Load-shedding				
Relay	With normally open contact			

⁽¹⁾ References to be defined by Schneider Electric front offices.

⁽²⁾ A type B may be required in some countries. Refer to local regulation.

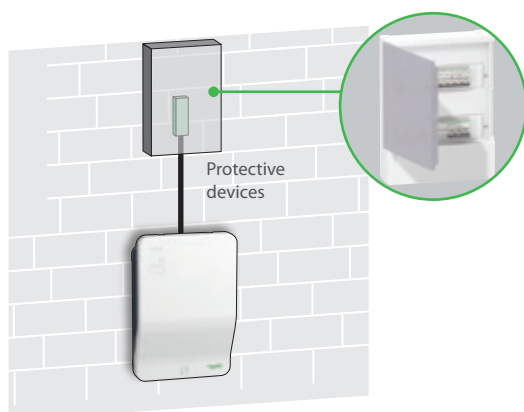

The charging station operates autonomously.
It has a dedicated protective device.

- > Installation: by an electrician
- > Location: residential, private usage

EVlink Wallbox

Accessory references

To connect the car to the charging station
EVlink Cable

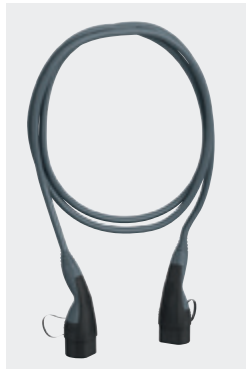

Available with a T1 or T2 connector.

Please refer to page 44

Electric vehicle simulation tool



Enables an operating check in the field of the charging station and charging cable.
Reference: [NCA93100](#)

Pedestal mounting pole



Floor standing of 1 or 2 Wallbox
Reference: [EVP1PBSSG](#)

Spare part references

Front panel



Reference

[EVP1HCWN](#)

Socket outlet

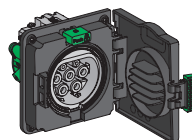

References

T2S single-phase	EVP1HSM41
T2 single-phase	EVP1HSM21
T2S three-phase	EVP1HSM43
T2 three-phase	EVP1HSM23

Key lock



References

Key lock Random ⁽¹⁾	EVP1HL5R
Key lock Single ⁽¹⁾	EVP1HL5S

⁽¹⁾ Example:
- If you order one [EVP1HL5R](#); you will receive 1 lock + 2 keys with same code.
- If you order one [EVP1HL5S](#); you will receive 10 locks + 20 keys with same code for all keys.

Attached cable

T1 charging connector



16 A single-phase	EVP2CNS161A4
32 A single-phase	EVP2CNS321A4

T2 charging connector



16 A single-phase	EVP2CNS161C4
32 A single-phase	EVP2CNS321C4

Flap



Reference

Flap T2/T2S socket Wallbox	EVP1HFS0
----------------------------	--------------------------



16 A three-phase	EVP2CNS163C4
32 A three-phase	EVP2CNS323C4

Practical information

> Dimensions (mm)

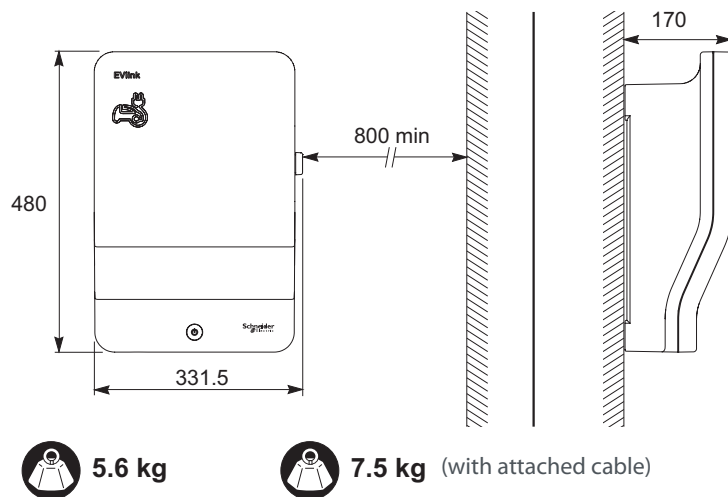

EcoStruxure™ Facility Expert

Register your charging station and improve your maintenance efficiency now with EcoStruxure™ Facility Expert.

- EcoStruxure™ Facility Expert is a simple, cloud-based tool that helps you organize maintenance records, follow-up on preventive maintenance, access log histories, create reports, and integrate remote alarming from your equipment.
- Let EcoStruxure™ Facility Expert help you optimize your maintenance activities. Download it for free on your PC or for your smart device at the Apple or Google Play store.
- You are ready to flash the product QR code with the EcoStruxure™ Facility Expert reader.



Additional information

Technical document	Language	References
With attached cable		
Quick start guide ⁽¹⁾	EN/ES/FR/DE	NHA31783
	IT/NL/PL/PT	NHA31784
Instruction sheet	EN/ES/FR/DE	NHA31787
	IT/NL/PL/PT	NHA31788
	NO/SV/FI	QGH34396
Without attached cable		
Quick start guide ⁽¹⁾	EN/ES/FR/DE	NHA31789
	IT/NL/PL/PT	NHA31790
Instruction sheet	EN/ES/FR/DE	NHA31778
	IT/NL/PL/PT	NHA31779
	NO/SV/FI	QGH34400

⁽¹⁾ Delivered with the Wallbox.

To download the above documents, do a search by reference on www.schneider-electric.com

EVlink Smart Wallbox

In short



Extensive choice

Range of 12 charging stations:

- Maximum charging power: 7.4 kW or 22.1 kW with a single-phase or three-phase power supply
- Maximum charging current can be adjusted from 8 A to 32 A
- T2 socket outlet with or without shutter
- T2 socket outlet with shutters + type E domestic socket outlet
- Attached cable with T1 or T2 connector
- Key locking or RFID user authentication

Charging station QR Code

- To get the product datasheet or to join Customer Care Center with "mySchneider" app, flash the QR Code with your usual QR Code reader.
- To access cloud-based EcoStruxure™ Facility Expert app maintenance organizer: charging station registration, maintenance reports, (see page 31)

Robustness

- Heavy duty socket outlet with silver plated contacts avoiding overheating
- High protection against mechanical impacts: IK10
- Suitable for outdoor use: IP54

Easy to install and commission

- Wall mounting or floor standing
- 1 or 2 charging stations on the same pole
- Easy wiring
- Integrated measuring of the apparent power
- Interface with an external MID energy meter
- Parameters setting through a web server embedded in the charging station

Energy management

- Delayed charging locally controlled by a wired contact to postpone charging to off-peak hours
- Temporary current limitation to a set value, controlled by a wired contact, to reduce the overall facility consumption and reduce the risk of power outage.
- Delayed charging and current limitation can also be controlled by the supervision (over OCPP) or by the building management system (over Modbus)

Versatile connection to a supervision

- Wired Ethernet: 3 ports
- Wi-Fi module as an accessory
- GPRS/3G modem as an accessory
- OCPP 1.5 or OCPP 1.6 interface

Optimized architecture

- Standalone or clustered architecture
- Connected or not to a supervision (through OCPP 1.5 or OCPP 1.6 communication protocols)



Product QR code
'FLASH ME'



Schneider Electric supports OCPP and is an active member of OCA (Open Charge Alliance).

Fleet car at home

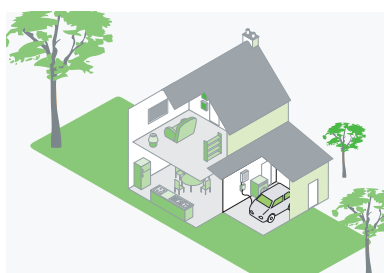

Condominium



Corporate and semi-public car parks



Application

Smart Wallbox is recommended for all private and semi-public areas whenever there are needs of user authentication, charging sessions monitoring or charging assets management.

Discovery

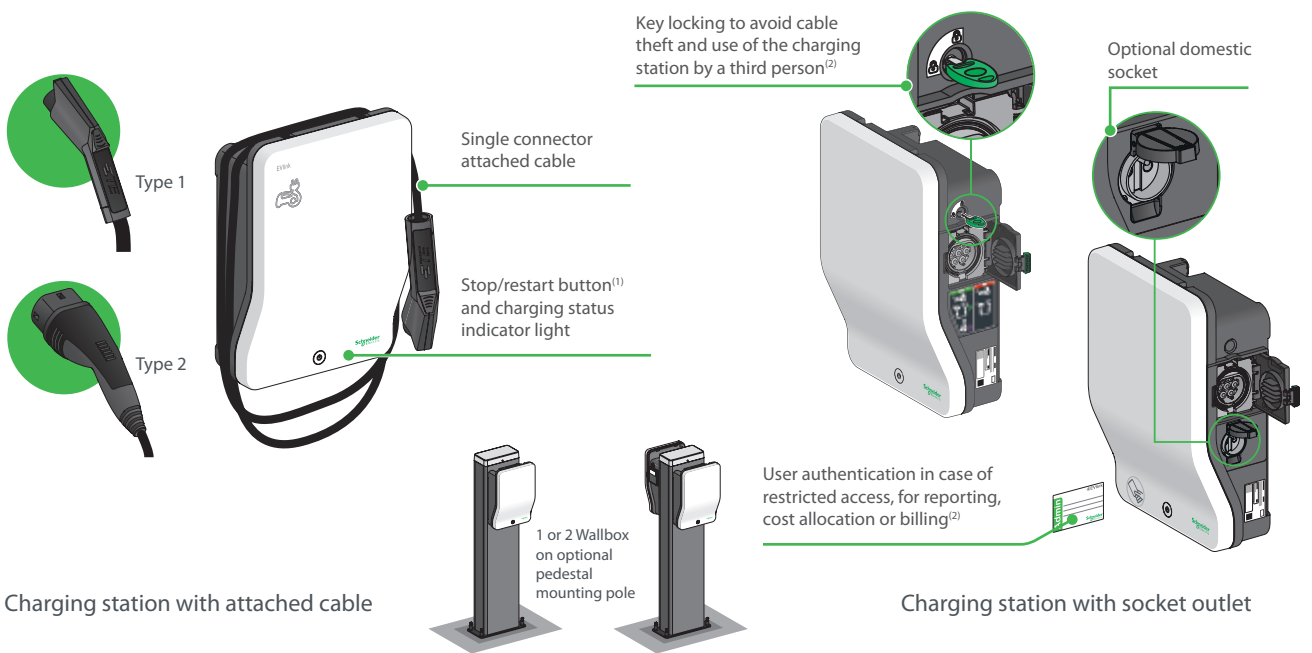

⁽¹⁾: also available with EVlink Smart Wallbox with attached cable
⁽²⁾: button can be deactivated with commissioning tool

Easy to install and commission

Installation by a single technician in less than 30 minutes; no special tools required

Top, bottom or back side wiring

Easy commissioning with a laptop connected to the embedded webserver

What's inside an EVlink Smart Wallbox



Scan or click on QR code

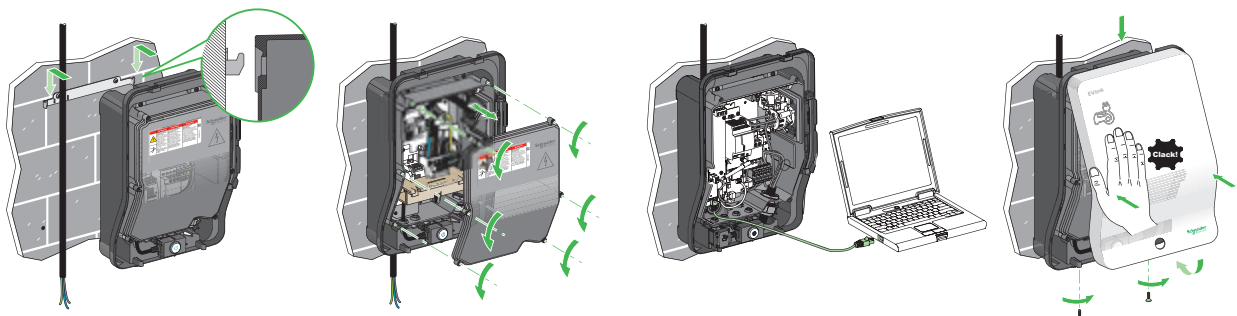

For example, you can:

- configure RFID badges. All RFID badges are accepted by default (factory setting)
- amend the maximum current values per socket
- activate the functions: load shedding and conditional outgoing line per socket
- produce maintenance reports
- ...

EVlink Smart Wallbox

Characteristics



Z.E. READY



Certification

EVlink Smart Wallbox has obtained the CB test certificate issued by the LCIE test laboratory, establishing compliance with the IEC 61851-1 and IEC 61851-22 standards.

Power supply

- Smart Wallbox can be supplied either in single-phase or in three-phase
- 220-240 V single-phase - 50/60 Hz
- 380-415 V three-phase - 50/60 Hz

Rated charging current

- T2/T2S socket-outlet: 8 A to 32 A (factory setting 16 A)
- TE socket-outlet: 10 A

Power consumption

- Power consumption of each conditional input (limitation and deferred start): 5 mA 24 V DC

Diagram of the earthing system

- TT, TN-S, TN-C-S
- IT (may require the addition of an isolating transformer for charging of certain vehicles)

Mechanical and environmental characteristics

- Ingress protection code: IP55
- Impact protection code: IK10
- Operating temperature: -30°C to +50°C
- Storage temperature: -40°C to +80°C
- Attached cable length: 4.5 m

Charging access

- Key locking
- User authentication through a RFID badge. Remote authentication by supervision or local setting of authorized badges
 - 13.56 MHz RFID reader for badges with chips Mifare Ultralight, Mifare Classic 1K / 4K, I Code SLI, Tag-it HFI, EM4135 ... (under ISO/IEC 14443 A&B, ISO/IEC 15693 protocols)
- Notes: RFID badges available on the market and standard are modified very often, so we advice to carry out prior test on our charging station to check compatibility
- 10 RFID badges provided with every RFID-type charging station

Warranty

- 24 months for the entire EVlink range

Standards

- IEC/EN 61851-1 ed 2.0
- IEC/EN 61851-22 ed 1.0
- IEC/EN 62196-1 ed 2.0
- IEC/EN 62196-2 ed 1.0

Connectivity

- Wired Ethernet: 3 ports
 - Port 1: LAN
 - Port 2: Wi-Fi or GPRS
 - Port 3: connection to PC for commissioning
- Wi-Fi module as an accessory
- GPRS/3G modem as an accessory
- OCPP 1.5 or OCPP 1.6 interface

Energy metering

- Integrated measuring of the apparent power
- Interface with an external MID energy meter

Commissioning

- Parameters setting through a web server embedded in the charging station.

Charging station references

> EVlink Smart Wallbox



Description	Socket outlet or connector type	Charging access	Power (kW) ⁽¹⁾ Phases	References
With socket outlet on right side - Silver plated contacts				
T2		Key	7.4 (1P) / 22.1 (3P)	EVB1A22P2KI*
		RFID ⁽²⁾	7.4 (1P) / 22.1 (3P)	EVB1A22P2RI*
T2 with shutter		Key	7.4 (1P) / 22.1 (3P)	EVB1A22P4KI*
		RFID ⁽²⁾	7.4 (1P) / 22.1 (3P)	EVB1A22P4RI*
T2 with shutter and TE (domestic)		Key	7.4 (1P) / 22.1 (3P)	EVB1A22P4EKI*
		RFID ⁽²⁾	7.4 (1P) / 22.1 (3P)	EVB1A22P4ERI*
With attached cable 4.5 m, on right side - Silver plated contacts				
T1		Key	7.4 (1P)	EVB1A7PAKI
		RFID ⁽²⁾	7.4 (1P)	EVB1A7PARI
T2		Key	7.4 (1P)	EVB1A7PCKI
		RFID ⁽²⁾	7.4 (1P)	EVB1A7PCRI
T2		Key	22.1 (3P)	EVB1A22PCKI
		RFID ⁽²⁾	22.1 (3P)	EVB1A22PCRI

⁽¹⁾ Factory setting: 16 A - and all RFID badges validated.

Can be replaced by customer setting (32 A, list of RFID badges...) using a PC via embedded webserver (see commissioning guide DOCA0060).

⁽²⁾ Includes 10 RFID badges.

* Shorter delivery time.

> Protective devices and optional equipment

New installation: supply line and protection devices must be defined for the highest power setting.

Description	Single-phase	Three-phase
Charging		
Rated Power - Current	7.4 kW - 32 A ⁽⁴⁾	22.1 kW - 32 A ⁽⁴⁾
Protection		
Circuit breaker (overcurrent) ⁽¹⁾	40 A Curve C	40 A Curve C
RCD (residual-current) ⁽¹⁾	30 mA type Asi ⁽²⁾	30 mA type B
Under voltage tripping auxiliary	A9N26969	A9N26969
Deferred start		
Relay	With normally open contact ⁽³⁾	
Load-shedding		
Relay	With normally open contact ⁽³⁾	

⁽¹⁾ References to be defined by Schneider Electric front offices.

⁽²⁾ A type B may be required in some countries. Refer to local regulation.

⁽³⁾ Smart Wallbox setting can be changed to "normally closed" is necessary, with commissioning tool.

⁽⁴⁾ without or with domestic socket.

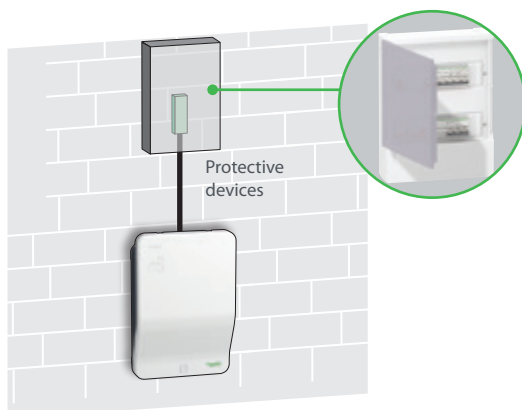

The charging station must be supplied by a dedicated branch circuit from the electrical switchboard.

EVlink Smart Wallbox

Accessory references

EVlink Cable

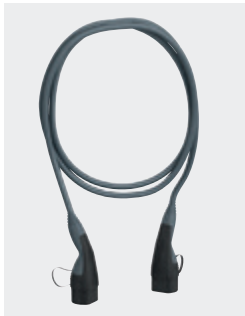

Available with T1 or T2 connector.

Please refer to page 44

Electric vehicle simulation tool



Enables operating check of the charging station and charging cable.
Reference: [NCA93100](#)

Pedestal mounting pole



Floor standing of 1 or 2 Smart Wallbox
Reference: [EVP1PBSSG](#)

Modem



Modems to be mounted inside the Smart Wallbox.
GPRS Modem
Reference: [EVP1MM](#) (antenna included)
GPRS/3G Modem
Reference: [EVP2MM](#) (available september 2017)
Antenna must be ordered separately:
Reference: [EVP2MX](#)

WiFi module

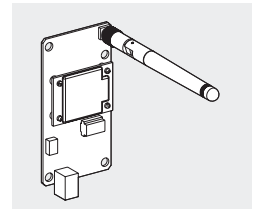

To be mounted inside the Smart Wallbox
Reference: [EVP1MWSI](#)

Pack of 10 RFID badges

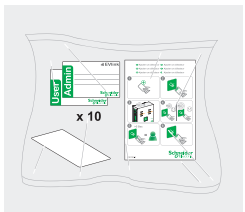

For charging stations equipped with an RFID reader. The badges are supplied blank, ready to be programmed to identify an administrator or user. Sheet of adhesive labels for badges: 1 administrator + 9 users.
Reference: [EVP1BNS](#)

Antenna for Smart Wallbox 3G modem

Ethernet cable 0.3 m included (available september 2017).
To be mounted inside the Smart Wallbox
Reference: [EVP2MX](#)

Spare part references

Front panel



Reference
[EVP1HCWN](#)

Socket outlet

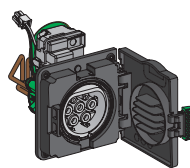

References
T2S
T2
TE

Key lock



References	
Key lock Random ⁽¹⁾	EVP1HLSR
Key lock Single ⁽¹⁾	EVP1HLSS

Attached cable

T1 charging connector



References	
32 A single-phase	EVP1CBS321A45

T2 charging connector



References	
32 A single-phase	EVP1CBS321C45



References	
32 A three-phase	EVP1CBS323C45

⁽¹⁾ Example:

- If you order one [EVP1HLSR](#): you will receive 1 lock + 2 keys with same code.
- If you order one [EVP1HLSS](#): you will receive 10 locks + 20 keys with same code for all keys.

Flap



Reference	
Flap T2/T2S socket Wallbox	EVP1HFS0

Practical information

> Dimensions (mm)

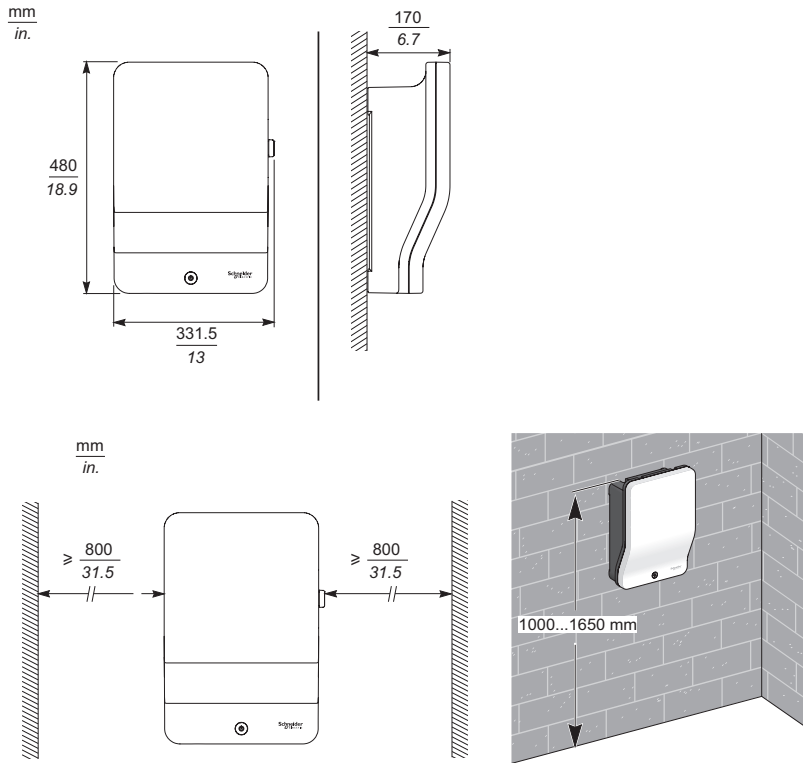

With socket outlets

 **6.2 kg (13.66 lb) - T2/T2S**

 **6.6 kg (14.55 lb) - T2/T2S + TE**

With attached cable

 **7.7 kg (15.43 lb) - 7.4 kW**

 **8.3 kg (17.63 lb) - 22.1 kW**

Additional information

Charging station technical document	Language	References
Installation Guide ⁽¹⁾ (model with socket outlet)	EN / FR / ES / IT	NHA95005
	DE / NL / NO / SV	NHA95006
Installation Guide ⁽¹⁾ (model with attached cable)	EN / FR / ES / IT	NHA95018
	DE / NL / NO / SV	NHA95021
User guide ⁽¹⁾	EN / FR / ES / IT	NHA95096
	DE / NL / NO / SV	NHA95097
Commissioning Guide ⁽²⁾ (standalone charging station)	FR	DOCA0060FR
	EN	DOCA0060EN

⁽¹⁾ Delivered with the product

⁽²⁾ To be downloaded

To download the above documents, do a search by reference on www.schneider-electric.com

EcoStruxure™ Facility Expert

Register your charging station and improve your maintenance efficiency now with EcoStruxure™ Facility Expert.

- EcoStruxure™ Facility Expert is a simple, cloud-based tool that helps you organize maintenance records, follow-up on preventive maintenance, access log histories, create reports, and integrate remote alarming from your equipment.
- Let EcoStruxure™ Facility Expert help you optimize your maintenance activities. Download it for free on your PC or for your smart device at the Apple or Google Play store.
- You are ready to flash the product QR code with the EcoStruxure™ Facility Expert reader.



EVlink Parking

In short



Extensive choice

Charging station offer

- Compliant with power supply network: 220-240 V / 380-415 V
- 7.4 kW or 22.1 kW (32 A for 230 / 400 V) and settable from 6 A to 32 A
- High robustness of Socket outlet (Type 2 or Type 2 with shutters) thanks to silver plated contact avoiding overheat
- Multiple configurations: user identification, one or two sockets outlets, floor-standing or wall-mounted

Charging station QR Code

- To get the product datasheet or to join Customer Care Center with "mySchneider" app, flash the QR Code with your usual QR Code reader.
- To access cloud-based EcoStruxure™ Facility Expert app maintenance organizer: charging station registration, maintenance reports, (see page 39)

Options

- Ethernet communication with supervision system via GPRS modem

Accessories offer

- Cables, RFID badges, cable holder, modem, etc.

Spare parts offer

- Floor base, wall base, socket outlet, caps, flap, etc.

Services offer

- Worldwide network of certified installers providing on-site installation, on-site commissioning, maintenance plan and on-demand repair and asset management contracts
- Worldwide customer care center

Optimized architecture

- Standalone or clustered architecture
- Connected or not to a supervision (through OCPP 1.5 or OCPP 1.6 communication protocols)
- Electrical protection devices in external cabinet or in the parking station floor base



Product QR code
'FLASH ME'



Cloud-connectable

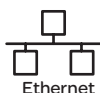

Ethernet

Easy commissioning with a laptop connected to the embedded webserver

For example, you can:

- configure RFID badges. All RFID badges are accepted by default (factory setting)
- amend the maximum current values per socket
- authorize the permanently attached cable (cable which remains attached permanently to the station)
- activate the functions: load shedding and conditional outgoing line per socket
- balance the charging powers (for 2-socket stations)
- produce maintenance reports
- ...

At home - condominium



At work

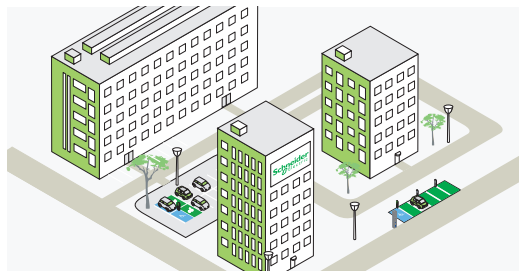

In short



Enhanced features

Benefit from advanced features and configure your charging station thanks to the EVLink embedded Web server.

- Adapt the charging station power demand to your electrical distribution:
 - configure load management per socket outlet or for the charging station
 - set automated load balancing between socket outlets for dual charging stations
 - set other related energy management features: load shedding, circuit breaker status, and postponed charge
- Select the relevant power-metering solution:
 - with current transformers already included in the cabinet
 - with additional power meters for higher metering precision, MID-compliant or not
- Adapt the charging station to your application:
 - activate or deactivate RFID badge reader
 - configure user privileges through RFID badge: VIP, administrators, regular users
 - select to allow the cable to remain permanently plugged in the charging station
 - configure IP address and network parameters
 - visualize Charge Detail Record (30 history)

Diagnosis and maintenance

- Perform diagnosis thanks to charging station front face LEDs or through the embedded Web server
- Restore factory default settings without a computer
- Upgrade the charging station with the latest firmware and benefit from additional features

Supervision capability

- Operate and maintain your charging infrastructure:
 - connect to supervision through OCPP 1.5 or OCPP 1.6 protocol
 - connect to local management system, such as Building Management System, through modbus TCP/IP



Schneider Electric supports OCPP and is an active member of OCA (Open Charge Alliance).

In private parking area



On street



EVlink Parking

Characteristics



The appearance may be customized on request.

Please do not hesitate to contact your Schneider Electric representative to assist you in this project.



> RoHS compliant
> Reach compliant
> EoL: End Of Life Process
> Product Environmental Profile compliant



Z.E. READY

Power supply network

- Earthing system: TT, TN-S, TN-C-S
 - IT (may require the addition of an isolating transformer for charging of certain vehicles)
- Frequency: 50 Hz or 60 Hz
- Socket outlet supply circuit (1 circuit per socket outlet):
 - 220/240 V 1P+N or
 - 380/415 V 3P+N
- Control circuit voltage (for charging station):
 - 220/240 V 1P+N

Charging modes

- Mode 2 with:
 - 10 A / Type E (FR standard) domestic socket
 - 10 A / Type F (DE standard) domestic socket
- Mode 3 with T2 socket outlet (with or without shutter)
- Communication between charging station and vehicle via charging cable as per IEC 61851

Charging access

User authentication through a RFID badge. Remote authentication by supervision or local setting of authorized badges

- 13.56 MHz RFID reader for badges with chips Mifare Ultralight, Mifare Classic 1K / 4K, I Code SLI, Tag-it HFI, EM4135 ... (under ISO/IEC 14443 A&B, ISO/IEC 15693 protocols)

Notes: RFID badges available on the market and standard are modified very often, so we advice to carry out prior test on our charging station to check compatibility

- 10 RFID badges provided with every RFID-type charging station

Mechanical and environmental

- Painted steel body, anti-corrosion treatment
- Protection: IP54 (IEC 60529), IK10 (IEC 62262)
- Operating temperature: -25°C to +40°C for Mode 2 / Mode 3 charging station
- Operating temperature: -25°C to +50°C for Mode 3 only charging station

IT Network connection

- TCP/IP
- FTP, SMTP or HTTP data retrieval
- Operations:
 - remote user authentication
 - retrieve data for Charging Data Record
 - charging station status monitoring
 - get remote commands

Certification

- CE and CB scheme (IEC 61851-1 and IEC 61851-22 standards)
- EV and ZE ready

Warranty

- 24 months for the entire EVlink range

Charging station references

> Floor standing



Without RFID reader

With RFID reader



Mode 3

Charging station type	No. of chargepoints	Socket outlet type Silver-plated contacts	Power per socket outlet / Phases		
			7.4 kW (1P - 32 A)	22.1 kW (3P - 32 A)	
Plug and charge - without RFID reader					
	1 ⁽¹⁾	T2		EVF2S7P02	EVF2S22P02
		T2 with shutters		EVF2S7P04	EVF2S22P04
	2	T2		EVF2S7P22	EVF2S22P22
		T2 with shutters		EVF2S7P44*	EVF2S22P44*
With RFID reader⁽²⁾					
	1 ⁽¹⁾	T2		EVF2S7P02R	EVF2S22P02R
		T2 with shutters		EVF2S7P04R	EVF2S22P04R*
	2	T2		EVF2S7P22R*	EVF2S22P22R*
		T2 with shutters		EVF2S7P44R*	EVF2S22P44R*

⁽¹⁾ On the right side of the charging station.

⁽²⁾ Includes 10 RFID badges.

* Shorter delivery time.

Mode 3/Mode 2

Charging station type	No. of chargepoints	Socket outlet type Silver-plated contacts	Power Phases		
			7.4 kW (1P - 32 A) 2.3 kW (1P - 10 A)	22.1 kW (3P - 32 A) 2.3 kW (1P - 10 A)	
Plug and charge - without RFID reader					
	1	T2 - TF		EVF2S7P2F	EVF2S22P2F
		T2 with shutters - TE		EVF2S7P4E	EVF2S22P4E
With RFID reader⁽¹⁾					
	1	T2 - TF		EVF2S7P2FR	EVF2S22P2FR*
		T2 with shutters - TE		EVF2S7P4ER	EVF2S22P4ER

⁽¹⁾ Includes 10 RFID badges.

* Shorter delivery time.

> Wall mounted



Without RFID reader

With RFID reader

Mode 3

Charging station type	No. of chargepoints	Socket outlet type Silver-plated contacts	Power per socket outlet / Phases		
			7.4 kW (1P - 32 A)	22.1 kW (3P - 32 A)	
Plug and charge - without RFID reader					
	1 ⁽¹⁾	T2		EVW2S7P02*	EVW2S22P02
		T2 with shutters		EVW2S7P04	EVW2S22P04*
	2	T2		EVW2S7P22	EVW2S22P22*
		T2 with shutters		EVW2S7P44*	EVW2S22P44*
With RFID reader⁽²⁾					
	1 ⁽¹⁾	T2		EVW2S7P02R	EVW2S22P02R
		T2 with shutters		EVW2S7P04R	EVW2S22P04R
	2	T2		EVW2S7P22R	EVW2S22P22R*
		T2 with shutters		EVW2S7P44R*	EVW2S22P44R*

⁽¹⁾ On the right side of the charging station.

⁽²⁾ Includes 10 RFID badges.

* Shorter delivery time.

EVlink Parking

Accessory references

Electric vehicle simulation tool



Enables an operating check in the field of the charging station and charging cable.
Reference: [NCA93100](#)

Modem



Modems to be mounted inside- external cabinet- Floor standing base, with EVP1FKC (Din rail mounting kit)

GPRS Modem
Reference: [EVP1MM](#) (antenna included)

GPRS/3G Modem
Reference: [EVP2MM](#) (available september 2017)
Antenna must be ordered separately:
Reference: [EVP2MP](#)

Antena for Parking 3G modem

Ethernet cable 1 m included (available september 2017).
Antenna to be mounted on the Floor base EVP2FBS (hole diam 22 mm)
Reference: [EVP2MP](#)

Pack of 10 RFID badges

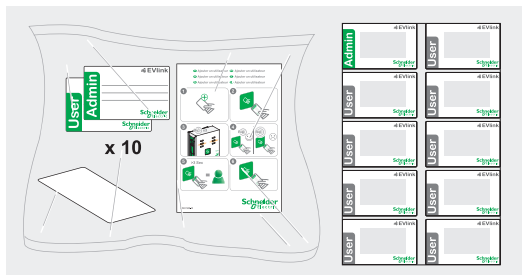

For charging stations equipped with an RFID reader.
The badges are supplied blank, ready to be programmed to identify an administrator or user.
Sheet of adhesive labels for badges: 1 administrator + 9 users.
Reference: [EVP1BNS](#)

Protective cover



For wall-mounted charging stations.
Blocks user access to cable sockets used for wiring.
Degree of protection: IK10
Reference: [EVP1WPSC](#)

Cable holder

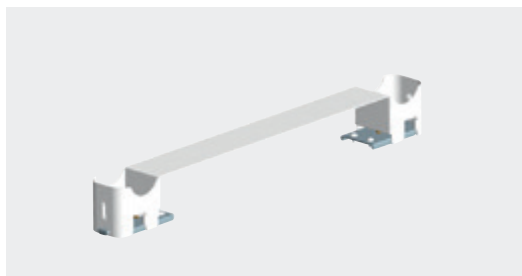

For floor-standing and wall-mounted EVlink Parking charging stations, (also compatible with EVF1....., EVW1..... and EVlink Parking charging stations.)
Allows the cable to be wound up for easy storage and locked on the holder.
Reference: [EVP1PH](#)

DIN rail mounting kit



For using the floor standing charging station as an electrical enclosure.
Compatible only with floor standing charging station (ref. EVF2) and floor standing base (ref. EVP2FBS).
Reference: [EVP1FKC](#)

EVlink Cable



Several vehicle connector/ plug combinations are available for charging stations.

Please refer to page 39

Please refer to page 44

Spare part references

Base

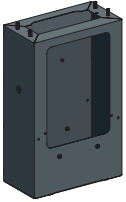

Floor-standing base.
Reference: [EVP2FBS](#)
See page 39



Wall-mounted base.
Reference: [EVP1WBS](#)

Enclosure



Characteristics	References
7.4 kW 1XT2	EVP2PE702*
7.4 kW 1XT2 RFID	EVP2PE702R
7.4 kW 1XT2S	EVP2PE704
7.4 kW 1XT2S RFID	EVP2PE704R
7.4 kW 2XT2	EVP2PE722
7.4 kW 2XT2 RFID	EVP2PE722R*
7.4 kW 2XT2S	EVP2PE744*
7.4 kW 2XT2S RFID	EVP2PE744R*
7.4 kW T2S-TE	EVP2PE74E
7.4 kW T2S-TE RFID	EVP2PE74ER
7.4 kW T2-TF	EVP2PE72F
7.4 kW T2-TF RFID	EVP2PE72FR
22.1 kW 1XT2	EVP2PE2202
22.1 kW 1XT2 RFID	EVP2PE2202R
22.1 kW 1XT2S	EVP2PE2204*
22.1 kW 1XT2S RFID	EVP2PE2204R*
22.1 kW 2XT2	EVP2PE2222*
22.1 kW 2XT2 RFID	EVP2PE2222R*
22.1 kW 2XT2S	EVP2PE2244*
22.1 kW 2XT2S RFID	EVP2PE2244R*
22.1 kW T2-TF	EVP2PE222F
22.1 kW T2-TF RFID	EVP2PE222FR*
22.1 kW T2S-TE	EVP2PE224E
22.1 kW T2S-TE RFID	EVP2PE224ER

* Shorter delivery time

Cap

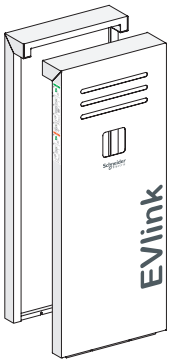

Floor standing.
Reference: [EVP2FCG](#)

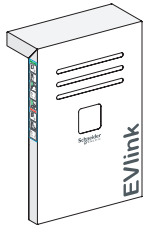

Wall mounted.
Reference: [EVP2WCG](#)

Socket outlet

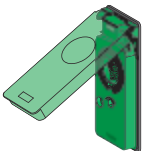

Green socket outlet T2.
Reference: [EVP1PSS2](#)

Green socket outlet
T2 with shutters.
Reference: [EVP1PSS4](#)



Green socket outlet TE.
Reference: [EVP1PSSE](#)

Green socket outlet TF.
Reference: [EVP1PSSF](#)

Flap



Green scooter flap.
Reference: [EVP1PFSS](#)

EVlink Parking

Practical information

> Content - Only one person required

Only one person is required to handle and install the floor-standing or wall-mounted charging station. This is possible thanks to delivery in three packages weighing less than 20 Kg each.

> Package contents and weight indication

Floor-standing charging station

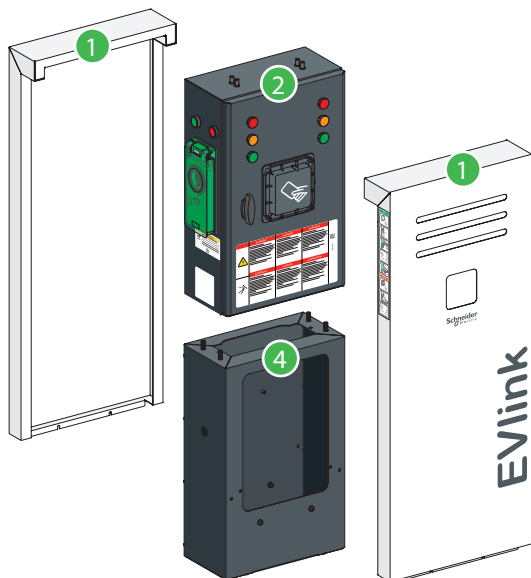

Wall-mounted charging station

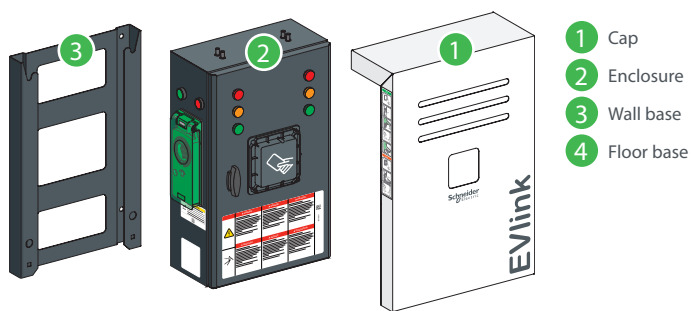

Charging station type		Floor-standing	Wall-mounted
Package	Composition	Weight	Weight
1	Cap	17 Kg	8 Kg
2	Enclosure	20 Kg	20 Kg
3	Wall base	-	5 Kg
4	Floor base	13 Kg	-

> Dimensions (mm)

Floor-standing charging station

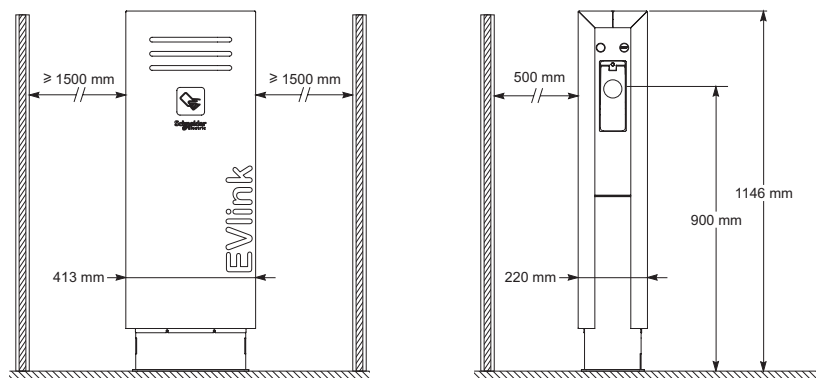

Wall-mounted charging station

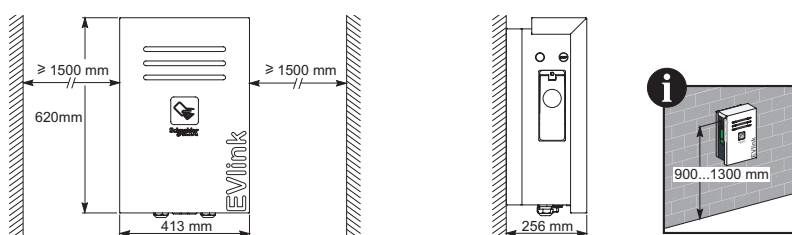

Additional information

Technical document	Language	References
Installation guide	EN / FR	NHA47410_EN_FR
	DE / RU	NHA47410_DE_RU
	IT / ES	NHA47410_IT_ES
	NO / SV	QGH34417
EVlink Parking: Electrical diagram	ES / DE / IT / RU / EN / FR	NHA81498
EVlink Commissioning Guide EVlink Parking	EN	DOCA0060EN

To download the above documents, do a search by reference on www.schneider-electric.com

Practical information

> Recommended protective devices per socket outlet

Description	Single-phase socket	Three-phase socket	Domestic socket
Charging	Single-phase socket	Three-phase socket	Domestic socket
Rated Power - Current	7.4 kW - 32 A	22.1 kW - 32 A	2.3 kW - 10 A
Protection			
Circuit breaker (overcurrent) ⁽¹⁾	40 A Curve C	40 A Curve C	16 A Curve C
RCD (residual-current) ⁽¹⁾	30 mA type Asi ⁽²⁾	30 mA type B	30 mA Type Asi
Under voltage tripping auxiliary	A9N26969	A9N26969	A9N26969

⁽¹⁾ References to be defined by Schneider Electric front offices.

⁽²⁾ A type B may be required in some countries. Refer to local regulation.

> Easy installation with DIN rail mounting kit ref.: EVP1FKC compatible with floor standing charging station ref.: EVF2 and floor standing base EVP2FBS

Thanks to a modular floor base, installers can prepare wiring of protection devices at their workshops. This accessory allows to power the charging station with only one power cable, even for 2 plug-charging stations.



EcoStruxure™ Facility Expert

Register your charging station and improve your maintenance efficiency now with EcoStruxure™ Facility Expert.

- EcoStruxure™ Facility Expert is a simple, cloud-based tool that helps you organize maintenance records, follow-up on preventive maintenance, access log histories, create reports, and integrate remote alarming from your equipment.
- Let EcoStruxure™ Facility Expert help you optimize your maintenance activities. Download it for free on your PC or for your smart device at the Apple or Google Play store.
- You are ready to flash the product QR code with the EcoStruxure™ Facility Expert reader.



Step 1:

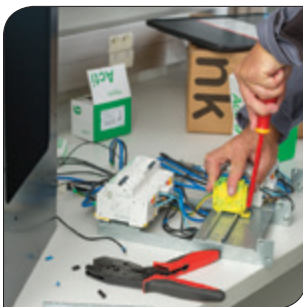

Wire protection device on the adapted rail.

Step 2:



Insert wired protection kit in the floor base.

Step 3:



Finish the wiring.

Step 4:



Install the prewired floor base on site.

What's inside an EVlink Parking charging station



Scan or click on QR code

EVlink Fast Charge solution*

In short



The choice

A high-end level product and several services:

- Installation management on your site
- Fast charge commissioning according to your application requirements
- Three levels (Ultra, Prime, and Plus) maintenance contract
- On-call and remote assistance in major countries worldwide
- Charging station upgrade with the latest firmware

Installation and commissioning

- Performed by Schneider Electric or certified partner
- A feasibility study should be carried out to assess the facility's ability. It will stipulate the necessary power, identify electrical duct routing, etc.
- The optimum level of protection and monitoring for the charging station

Maintenance

- On-line charging station support and diagnosis
- On-line software upgrades
- Schneider Electric promotes maintenance contracts on customer request for uptime optimization

Application

EVlink Fast Charge stations are designed to charge a vehicle rapidly: 80% of capacity charged in less than 30 minutes.

They are intended for service stations in particular.

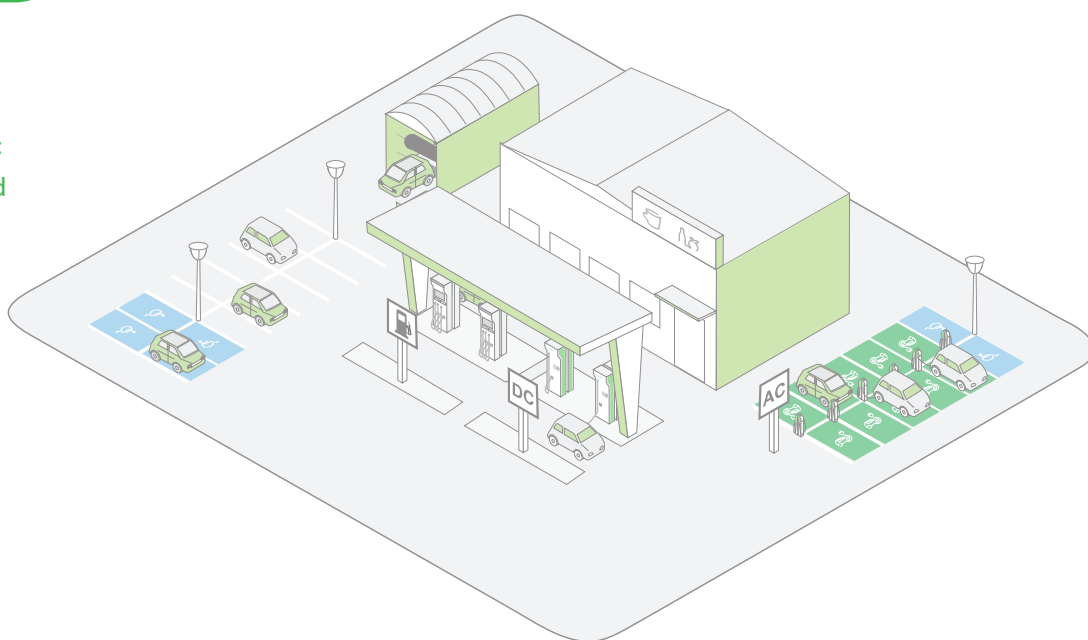

* Offer limited to selected countries with project management mode.

Characteristics

Mechanical and environmental features

- Degree of protection: IP54 (except cordsets)
- Degree of mechanical protection: IK10
- Operating temperature: -30°C / +50°C

Power supply network and charging mode

- Power supply: 400 V~ (+10 / -15%), 3 Ph, 50 – 60 Hz

Direct current charging station

- Charging in Mode 4 (IEC 61851-23)
- CHAdeMO type connector
- Combo 2 type connector
- Charging voltage/current: 500 V DC/125 A - 485 V DC with CHAdeMO connector
- Electrical protective devices integrated in the charging station
- Cable length: 4 m

Alternating current charging station

- Charging in Mode 3 (IEC 61851-22)
- Charging voltage/current: 400 V AC/63 A AC
- Electrical protective devices integrated in the charging station
- Cable length: 4.4 m

User dialogue and data

- Backlit LCD graphic screen (2 lines)
- 4 sensitive touch buttons
- 3 twin-colored LED status indicators
- CPU badge (with RFID)
- Contactless reader

Available options

- Painting and skinning (stickers)
- Barcode reader
- On request:
 - Supervision connection (third party supervision integration)
 - Payment

Standards

- IEC/EN 61851-1 ed 2.0
- IEC/EN 61851-22 ed 1.0
- IEC/EN 62196-1 ed 2.0
- IEC/EN 62196-2 ed 1.0

Commercial configuration*

Product type	500 V DC	500 V DC + 400 V~
Combo2 50 kW DC/CHAdeMO 50 kW DC/AC 43 kW	Please contact us	
Combo2 50 kW DC/CHAdeMO 50 kW DC/AC 22.1 kW		
Combo2 50 kW DC/CHAdeMO 50 kW DC		
Combo2 50 kW DC		
Combo2 50 kW DC/AC 43 kW		
Combo2 50 kW DC/AC 22.1 kW		
CHAdeMO 50 kW DC		
CHAdeMO 50 kW DC/AC 43 kW		
CHAdeMO 50 kW DC/AC 22.1 kW		

* Offer limited to selected countries with project management mode.

Electric vehicle simulation tool

In short

Electric vehicle simulation tool



Reference: NCA93100



> ROHS compliant
 > Reach compliant
 > EoLi: End Of Life Process
 > Product Environmental Profile compliant

Tool for trained electricians

To check correct operation of a charging station

- EVlink Wallbox
- EVlink Smart Wallbox
- EVlink Parking
- EVlink City
- Any charging station complying with IEC 61851-1, by simulation of a vehicle during charging

All-terrain use

Robustness

- IK strength: IK8
- Resists falls of up to 1 m
- IP54: closed
- IP44: open

Easy to carry

- Weight: 6 Kg

Compatibility

Accepts any cable fitted with a T1 or T2 connector.
 Single-phase or three-phase alternating current charging.

BNC connectors:

- Measurement of the resistance in a charging cable connector
- Observation of charging currents and PWM communication signals on oscilloscope

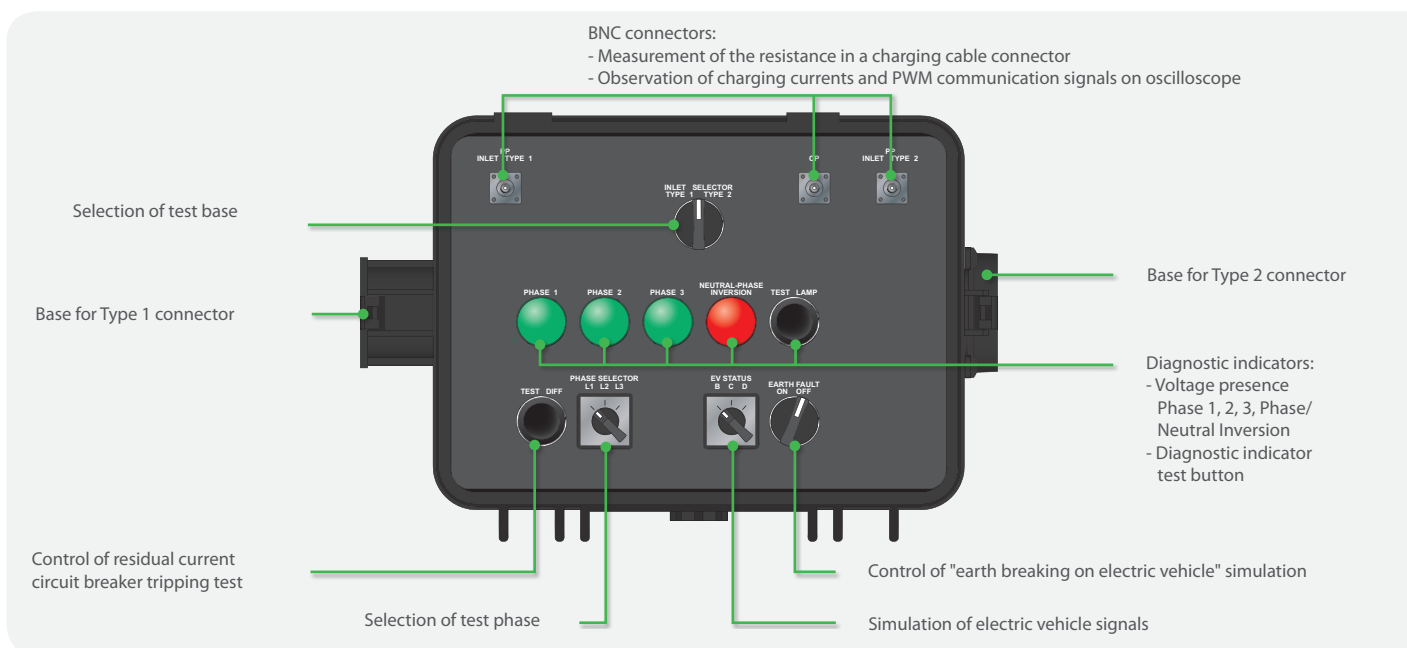

how to use an electric vehicle simulation tool



Scan or click on QR code

Perfectly simple ...

Once the simulation tool is connected to the charging station, charging is started thanks to a button: the result is shown by an indicator lamp. A few minutes is all that's needed to check correct charging station operation.

... and standalone

Power supply via the charging cable.
 No internal battery, so unlimited time for servicing operations and for your peace of mind.

Characteristics

Characteristics of the power supply network

- The simulation tool is powered via the charging current
- Network frequency: 50 Hz or 60 Hz
- Earthing system: TT or TN (do not use in IT)
- Voltages:
 - 230 V \sim on type 1 connector
 - 400 V \sim on type 2 connector
- Charging current during test < 1 A

Mechanical and environmental characteristics

- Degree of protection (as per IEC 60529):
 - closed: IP54
 - open: IP44
- Degree of mechanical protection (as per IEC 62262): IK8
- Dimensions (H x L x D): 270 x 305 x 170 mm
- Weight: 6 Kg
- Left-hand base:
 - Type 1 inlet • IEC 62196 type 1 • U: 230V1 • I: < 1 A • F: 50 – 60 Hz
- Right-hand base:
 - Type 2 inlet • IEC 62196 type 2-II • U: 400V3 \sim • I: < 1 A • F: 50 – 60 Hz
- Storage temperature: -30°C / +50°C
- Operating temperature: -30°C / +50°C
- Risk of mechanical damage to the simulation tool if dropped at a temperature < -2°C
- Relative humidity rate (RH): < 95%

Accessories and documents included

- Plasticized user's manual attached under the cover
- Detailed user manual (to be downloaded from the Web)
- BNC/banana plug adapter cord

Certification

- The electric vehicle simulation tool complies with standards IEC 61010-1 and IEC 61851-1

Recommended measuring instruments for additional tests

- Ohmmeter: to measure the resistance in the customer's cable connector
- Oscilloscope: for observation of signals during the electric vehicle status simulation test (signals in accordance with the IEC 61851 standard)

As a complement: EVlink charging cables

They are necessary for testing the charging stations.



Several vehicle connector/plug combinations are available for charging stations.

Please refer to page 44

EVlink cable

Characteristics

EVlink cable for charging stations:

Mobility within arm's reach

Type 1 (T1) Type 2 (T2) Type 3 (T3)

- Tested and certified product: Third-part laboratory CB certification (LCIE) complies with applicable standard IEC 62196
- High protection, fast charging (Mode 3)
- High-strength cable

Characteristics

- Length: 5 m
- Max. current: 32 A
- Operating temperature: -30°C to +50°C
- Degree of protection: IP44

Two good reasons to have a second EVlink cable in your electric vehicle

- 1 To take advantage of the charging capacity of public charging stations: by having an appropriate EVlink cable for the charging stations used, you obtain fast charging with high protection.
- 2 To have a fallback solution. E.g.: charging cable damaged or misplaced, help out another electric vehicle user.

Which EVlink cable

for which electric vehicle?

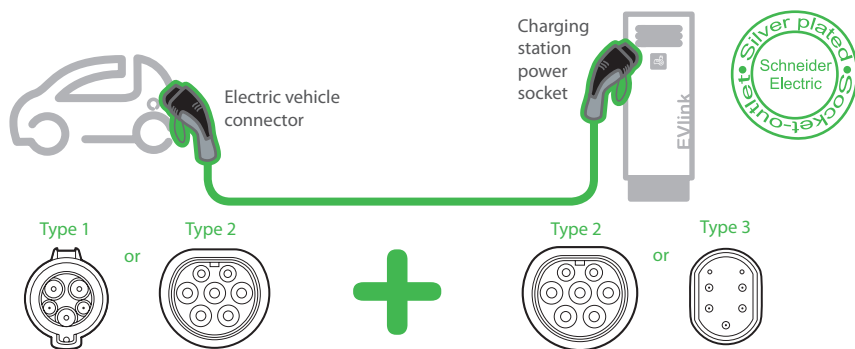

References	No. of phases		Charging power accepted (kW)				Weight (Kg)	Cable length (m)	
	1	3	3.7	7.4	11	22.1			
 T1 + T2	●		●	●			2.4	5	
	EVP1CNS32121			●	●			3.0	7
 T2 + T3	●		●	●			2.5	5	
	EVP1CNS32132		●	●	●	●	3.2	5	
 T2 + T2	●		●	●			2.5	5	
	EVP1CNS32122	●		●	●			3.1	7
	EVP1CNL32122*		●	●	●	●	3.2	5	
	EVP1CNS32322		●	●	●	●	4.1	7	
EVP1CNL32322*		●	●	●	●				

* Available september 2017





EVlink

Managing charging station energy

EVlink energy management

Energy management

Energy management stakes

> Energy management: why do it ?

- Avoids facility disruption, causing operating losses
- Reduces energy and electrical infrastructure costs
- Increases driver satisfaction
- Makes operations more efficient

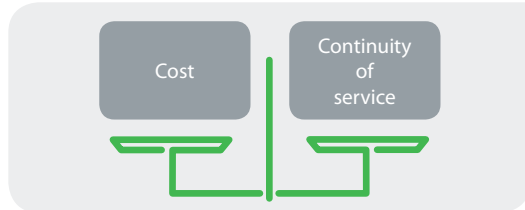

> And for charging stations, how does it work?

Allow simultaneous charging of the largest number of vehicles as quickly as possible ...

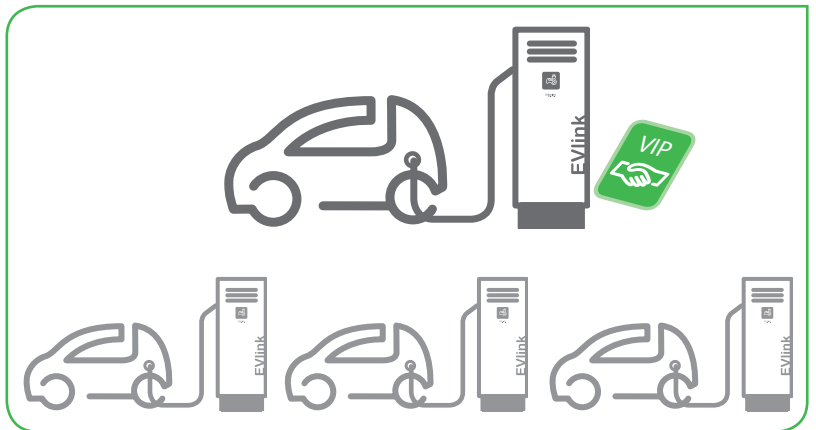

... while maintaining charging priority privileges, if necessary.

> How to implement energy management?

Power limit

The "power subscription" with the energy supplier, or the maximum power supply capacity (depending on cable cross section, circuit breakers rating, etc.).

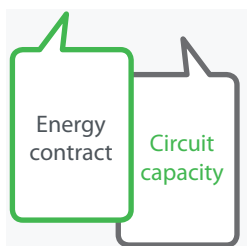

Measurements

The total power demand of each charging point.

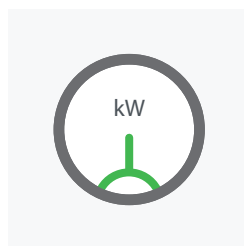

Controller

The controller performs data acquisition and runs the algorithms to control total demand and power allocation to the vehicles.



Actuators

The charging stations that can execute an order and temporarily limit the current supplied to the vehicle.

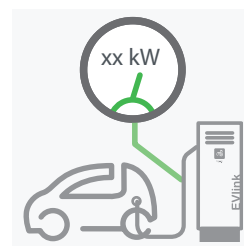

Scalable energy management solutions



Whether for a small or large electric vehicle charging infrastructure, requirements for energy cost reduction or continuity of service make sense.

This is especially true for investors wishing to future-proof their investment. For example, electric vehicle autonomy will increase thanks to battery capacity improvement, thus requiring more energy to be delivered by charging station as quickly as possible.

Energy management can be provided in two complementary ways



Standalone charging stations



Clusters of charging stations

The architecture and implementation vary accordingly but the key benefits remain: lower investment, lower utility bills, tripping avoidance.



Energy management for Standalone charging station

The activation of this embedded feature makes it possible to limit the maximum power of a dual socket outlet charging station and to balance the load between the two socket outlets, so as to charge the vehicles as quickly as possible while remaining within the maximum power limit set for the charging station.

The charging station thus reduces the power delivered to the electric vehicles if they require more power than the maximum power setting.



Provide optimum flexibility

The maximum power of the charging station can be set:

- In the settings, through the embedded Web server. This value can be changed at any time with a few clicks.
- Remotely by an external system, either as a permanent value or dynamically. This remote setting by a central system can be done by:
 - a back-end Charge Point Operator, through OCPP
 - a Building Management System, an energy management system, or any other local system through Modbus.

Cluster of charging stations supplied by the facility network*



This is the case for charging stations whose administrative and technical management is grouped with that of a facility. An example is a company with a fleet of vehicles.

Overall energy management (facility + station) is recommended, in particular when the maximum power of the charging station (simultaneous use of socket outlets at full power) is significant by comparison with that of the facility.



Building automation and EVlink energy management, complementary systems

In some buildings, automatic control systems supervise total consumption and adapt the operation of certain devices to optimize power consumption and energy costs without adversely affecting work efficiency and occupant comfort.

The total consumption and that of the charging stations are constantly transmitted to the charging station's controller. When this value approaches the limit set by the energy contract, the EVlink energy management program sends the charging stations an order temporarily limiting charging. It is also possible for the building management system to dynamically set the maximum power to the cluster of charging station.

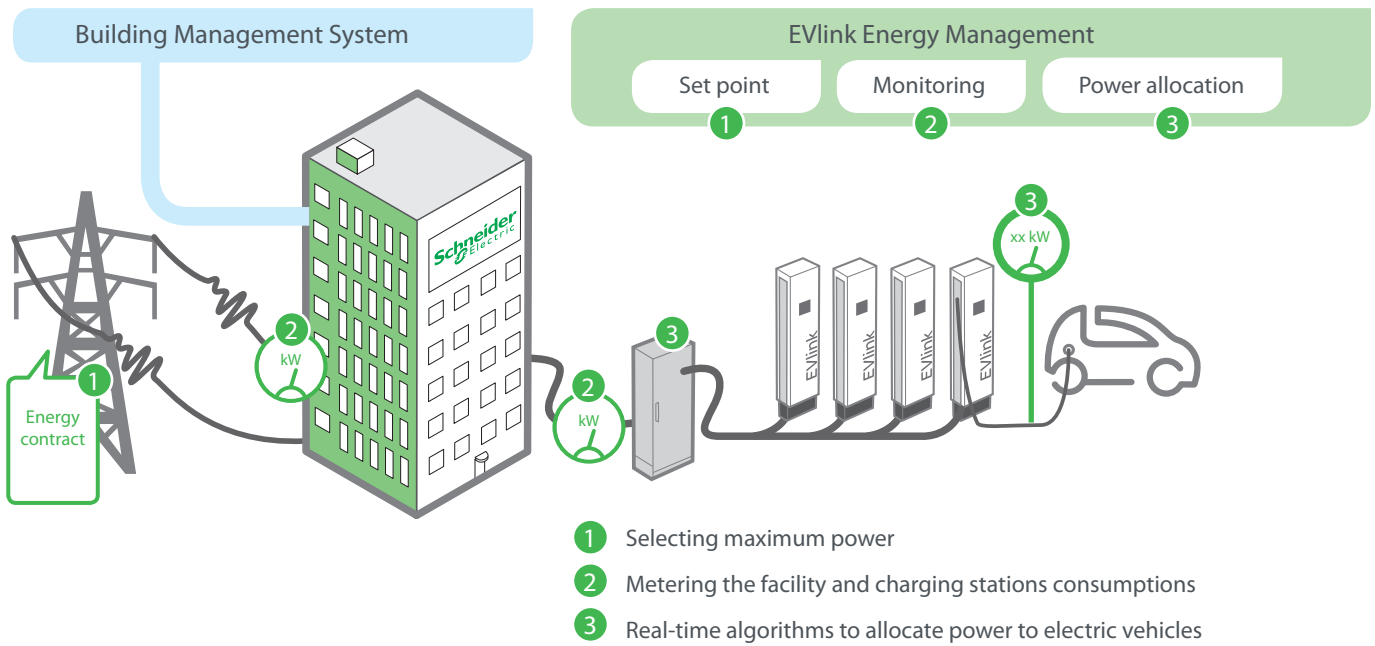

Power monitoring

Dynamic power allocation: EVlink energy management maximum power set point is calculated in real time.

--- Limiting
 — Charging station power

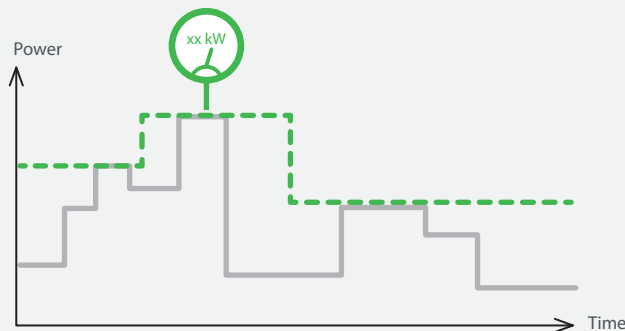

* Offer limited to selected countries with project management mode.

Cluster of charging stations directly supplied by the utility grid*



The charging station's energy is supplied directly by the electricity distribution system. The installation includes a power meter and a circuit breaker set to the subscribed demand. This case generally applies to Parking charging stations for which management is independent from a facility. Energy management is systematically recommended to optimize capital costs and energy supply subscription costs.



EVlink Energy Management, for compliance with the energy contract

In the protection and control panel, EVlink Energy Management program loaded in the controller helps to ensure energy management.

The maximum power set point parameter is configured during commissioning, together with the charging points power allocation scenario (see description on the next page).

The controller constantly monitors the charging station's total power. Based on this information, if necessary, it can activate or disable charging station power limitation.

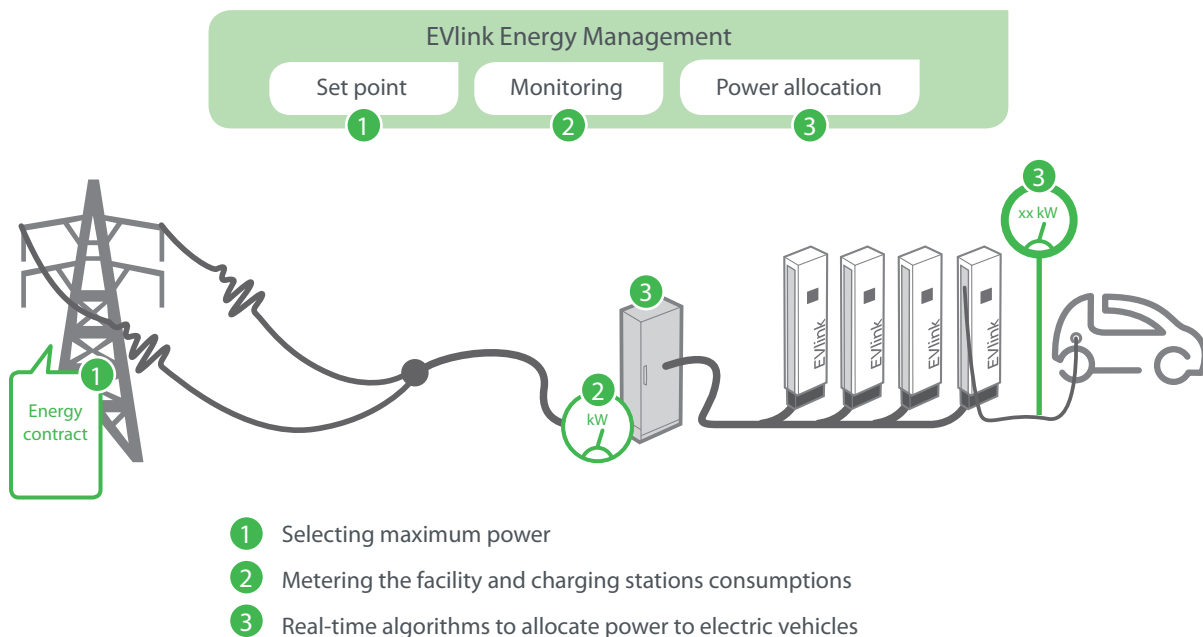

Power monitoring

With 'Static power allocation' the maximum power set point value is equal to the subscribed demand or any fixed value. This mode can also be adopted when the charging station is supplied by a facility network. In that case the set point depends on the electrical sizing of the charging station's power supply circuit, or operational needs.

- Maximum set point
- Charging station power

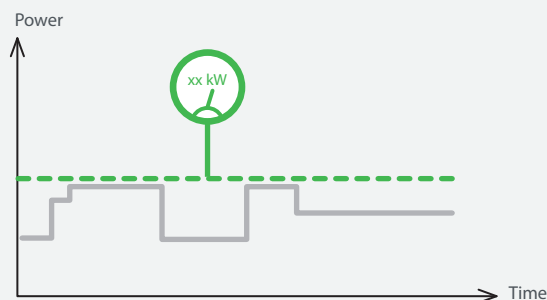

* Offer limited to selected countries with project management mode.

Control of cluster of charging stations*

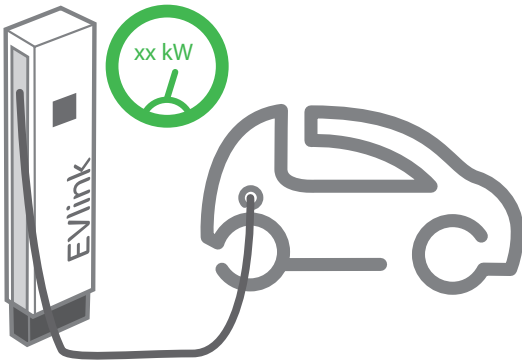

Each charging station can limit its output

Once a vehicle is connected, charging can begin, but the output can be automatically limited by the charging station either to comply with restrictions regarding maximum power of the vehicle charger, the charging cable, or the charging station or on receiving an order from EVlink energy management controller and algorithms.

EVlink energy management power allocation scenarios

The controller performing energy management can reduce the charging station's power by sending orders to the charging points at any time.

A choice of scenarios is set during commissioning, making it possible to take into account varied needs related to the use of the vehicles that will be charged.

Proportional scenario

The output of each charging station is reduced by an identical percentage. Case of charging stations for vehicles and drivers having equal privileges.

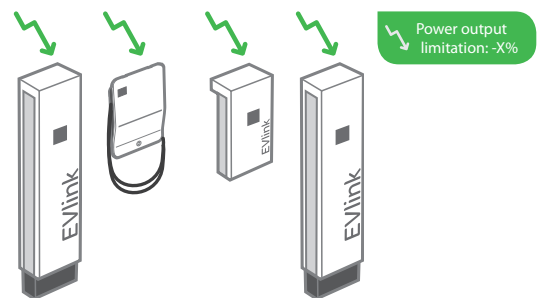

Low-power scenario

The output of the charging stations with highest power requirement is reduced first.

Case of charging stations where the strategy is to provide the same quantity of energy to vehicles in the event of a reduction in the available power.



VIP badge privileges

The station charging a vehicle identified by a priority badge does not apply the requested reduction or only partially.

Case of charging stations with RFID badge authentication. Charging of certain vehicles is not penalized for service reasons or to give priority to customers.

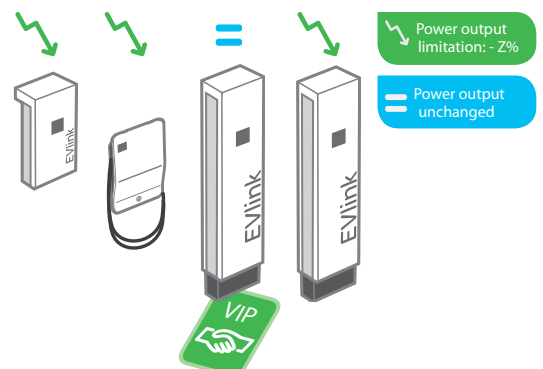

* Offer limited to selected countries with project management mode.



EVlink



EVlink

Solutions for your project

"Turnkey" project

Services for contractors

Services for operators

Solutions for your project



Listen Understand Propose

Your Schneider Electric correspondent is a professional, specialized in the charging infrastructure solution.

Based on the technical and economic data of your charging station project, he or she will propose the appropriate solution:

- "Turnkey" charging station project performed by Schneider Electric
- Sale of charging stations and services with possible support at start-up.

Preliminary technical audit

To contract the optimum solution.

For example, this service is essential when the charging station power could jeopardize the electrical infrastructure of an existing facility.

"Turnkey" project

The charging station project is proposed to you in a contractual document

It specifies the following information:

- Precise characteristics of the structure
- Schedule of the various project phases and a delivery date
- Technical documents submitted for operation and maintenance
- Conditions of support services

On the agreed date, Schneider Electric will deliver the complete solution in operating conditions and allowing on-site training of operating personnel.



The project is managed entirely to the Electric Vehicle Center of Expertise.

A single contact for the project team, whatever the subject, commercial or technical.



Energy management and supervision are key to the expertise of project teams



Solutions

- EVlink Energy Management is generally included in "turnkey" projects.

Services for contractors



Designers, installers ...
Develop new competencies, get support from our specialists
to make your business more efficient



Training on regulations, electrical and communication architectures, setup, tests and maintenance for contractors

- Charging station design principles.
- Learning about and mastering Schneider Electric standard architectures, charging stations, components, and monitoring services.
- Training in assembly, operating tests and maintenance procedures.



Technical support during projects

If necessary, priority access to our specialists is provided through a hotline or on-site as a paying service.

Services for operators



Private or public parking operators, fleet managers ...

Schneider Electric helps you save time and preserves your peace of mind through optimization of your charging station infrastructure.



Technical monitoring:
constant charging station supervision
and diagnosis

If Schneider Electric specialists detect any anomaly, an initial diagnosis is performed. The operator is informed and can be guided through simple reboot operations.

If necessary, a partner firm may be called on to provide support.



Maintenance:
preserving availability

Schneider Electric has trained a network of local installer-partners.

They perform routine maintenance of your charging stations and perform repairs if necessary. They are supported by our Customer Care Centers.



Expert appraisal/advice:
making the most of your charging station

Based on the activity and consumption reports, our experts establish an efficiency diagnostic of the installation based on energy cost and equipment availability criteria.

If necessary, operating advice and proposals for technical improvement are submitted.



EVlink

Schneider
Electric

EVlink
Schneider Electric

EVlink
Schneider Electric

List of references

Link for mySchneider App download



mySchneider app gives access to

- Customer Care Center
- On line Schneider-electric catalogues
- Green Premium information
- ...

Electric vehicle news on the website



- Information
- Advice
- Charging solutions and much more!

schneider-electric.com/electric-vehicle

EVlink

EVlink Wallbox charging stations

Characteristics ⁽¹⁾	References
Charging stations with socket outlet	
3.7 kW – T2	EVH2S3P02K
7.4 kW – T2	EVH2S7P02K
11 kW – T2	EVH2S11P02K
22.1 kW – T2	EVH2S22P02K
3.7 kW – T2 with shutters	EVH2S3P04K
7.4 kW – T2 with shutters	EVH2S7P04K
11 kW – T2 with shutters	EVH2S11P04K
22.1 kW – T2 with shutters	EVH2S22P04K
Charging stations with attached cable	
3.7 kW – T1	EVH2S3P0AK
7.4 kW – T1	EVH2S7P0AK
3.7 kW – T2	EVH2S3P0CK
7.4 kW – T2	EVH2S7P0CK
11 kW – T2	EVH2S11P0CK
22.1 kW – T2	EVH2S22P0CK

⁽¹⁾ Charging station characteristics = Power – Socket outlet or connector type.

Spare parts	References
Front panel	
Front panel	EVP1HCWN
Key lock	
Key lock random	EVP1HLSR
Key lock single	EVP1HLSS
Flap	
Flap T2 socket Wallbox	EVP1HFS0
Socket outlet	
Socket outlet T2S single-phase	EVP1HSM41
Socket outlet T2 single-phase	EVP1HSM21
Socket outlet T2S three-phase	EVP1HSM43
Socket outlet T2 three-phase	EVP1HSM23
Attached cable	
Attached cable T1 16 A single-phase	EVP2CNS161A4
Attached cable T1 32 A single-phase	EVP2CNS321A4
Attached cable T2 16 A single-phase	EVP2CNS161C4
Attached cable T2 32 A single-phase	EVP2CNS321C4
Attached cable T2 16 A three-phase	EVP2CNS163C4
Attached cable T2 32 A three-phase	EVP2CNS323C4
Pedestal mounting base	
Pedestal mounting base for floor standing of 1 or 2 Wallbox or Smart Wallbox	EVP1PBSSG

EVlink Smart Wallbox charging stations

Characteristics ⁽¹⁾	References
Charging stations with socket outlet	
7.4 / 22.1 kW – T2 - Key lock	EVB1A22P2KI
7.4 / 22.1 kW – T2 - RFID	EVB1A22P2RI
7.4 / 22.1 kW – T2 shutter - Key lock	EVB1A22P4KI*
7.4 / 22.1 kW – T2 shutter - RFID	EVB1A22P4RI*
7.4 / 22.1 kW – T2 shutter + TE - Key lock	EVB1A22P4EKI*
7.4 / 22.1 kW – T2 shutter + TE - RFID	EVB1A22P4ERI*
Charging stations with 4.5 m attached cable	
7.4 kW – T1 - Key lock	EVB1A7PAKI
7.4 kW – T1 - RFID	EVB1A7PARI
7.4 kW – T2 - Key lock	EVB1A7PCKI
7.4 kW – T2 - RFID	EVB1A7PCRI
22.1 kW – T2 - Key lock	EVB1A22PCKI
22.1 kW – T2 - RFID	EVB1A22PCRI
Accessories	
Pack of 10 RFID badges	EVP1BNS

⁽¹⁾ Charging station characteristics = Power – Socket outlet or connector type.

* Shorter delivery time.

Spare parts	References
Front panel	
Front panel	EVP1HCWN
Key lock	
Key lock random	EVP1HLSR
Key lock single	EVP1HLSS
Flap	
Flap T2 socket Wallbox	EVP1HFS0
Socket outlet	
Socket outlet T2S three-phase	EVP1BSE43
Socket outlet T2 three-phase	EVP1BSE23
Socket outlet TE domestic single-phase	EVP1BSSE
Attached cable	
Attached cable T1 32A single-phase	EVP1CBS321A45
Attached cable T2 32A single-phase	EVP1CBS321C45
Attached cable T2 32A three-phase	EVP1CBS323C45
Communication interfaces	
WiFi module	EVP1MWSI
GPRS modem	EVP1MM
GPRS/3G modem	EVP2MM*
GPRS/3G modem antenna for EVlink Smart Wallbox	EVP2MX*
Pedestal mounting base	
Pedestal mounting base for floor standing of 1 or 2 Wallbox or Smart Wallbox	EVP1PBSSG

* Available september 2017

Additional offer

Test tool	Reference
Electric vehicle simulation tool	NCA93100

EVlink Parking charging stations

Characteristics ⁽¹⁾	References
Floor-standing charging stations	
7.4 kW – 1 x T2	EVF2S7P02
7.4 kW – 1 x T2 – RFID	EVF2S7P02R
7.4 kW – 1 x T2 with shutters	EVF2S7P04
7.4 kW – 1 x T2 with shutters – RFID	EVF2S7P04R
7.4 kW – 2 x T2	EVF2S7P22
7.4 kW – 2 x T2 – RFID	EVF2S7P22R*
7.4 kW – 2 x T2 with shutters	EVF2S7P44*
7.4 kW – 2 x T2 with shutters – RFID	EVF2S7P44R*
7.4 / 2.3 kW – T2 / TF	EVF2S7P2F
7.4 / 2.3 kW – T2 / TF – RFID	EVF2S7P2FR
7.4 / 2.3 kW – T2 with shutters / TE	EVF2S7P4E
7.4 / 2.3 kW – T2 with shutters / TE – RFID	EVF2S7P4ER
22.1 kW – 1 x T2	EVF2S22P02
22.1 kW – 1 x T2 – RFID	EVF2S22P02R
22.1 kW – 1 x T2 with shutters	EVF2S22P04
22.1 kW – 1 x T2 with shutters – RFID	EVF2S22P04R*
22.1 kW – 2 x T2	EVF2S22P22
22.1 kW – 2 x T2 – RFID	EVF2S22P22R*
22.1 kW – 2 x T2 with shutters	EVF2S22P44*
22.1 kW – 2 x T2 with shutters – RFID	EVF2S22P44R*
22.1 / 2.3 kW – T2 / TF	EVF2S22P2F
22.1 / 2.3 kW – T2 / TF – RFID	EVF2S22P2FR*
22.1 / 2.3 kW – T2 with shutters / TE	EVF2S22P4E
22.1 / 2.3 kW – T2 with shutters / TE – RFID	EVF2S22P4ER
Wall-mounted charging stations	
7.4 kW – 1 x T2	EVW2S7P02*
7.4 kW – 1 x T2 – RFID	EVW2S7P02R
7.4 kW – 1 x T2 with shutters	EVW2S7P04
7.4 kW – 1 x T2 with shutters - RFID	EVW2S7P04R
7.4 kW – 2 x T2	EVW2S7P22
7.4 kW – 2 x T2 – RFID	EVW2S7P22R
7.4 kW – 2 x T2 with shutters	EVW2S7P44*
7.4 kW – 2 x T2 with shutters - RFID	EVW2S7P44R*
22.1 kW – 1 x T2	EVW2S22P02
22.1 kW – 1 x T2 – RFID	EVW2S22P02R
22.1 kW – 1 x T2 with shutters	EVW2S22P04*
22.1 kW – 1 x T2 with shutters - RFID	EVW2S22P04R
22.1 kW – 2 x T2	EVW2S22P22*
22.1 kW – 2 x T2 – RFID	EVW2S22P22R*
22.1 kW – 2 x T2 with shutters	EVW2S22P44*
22.1 kW – 2 x T2 with shutters - RFID	EVW2S22P44R*
Accessories	
Parking cable holder	EVP1PH
Protective cover – only for wall-mounted parking charging station	EVP1WPSC
Protection kit	EVP1FKC
Pack of 10 RFID badges	EVP1BNS

⁽¹⁾ Charging stations characteristics = Power – Number x type of socket outlet – RFID: badge reader.
* Shorter delivery time.

EVlink Parking charging stations

Spare parts	References
Enclosure	
7.4 kW – 1 x T2	EVP2PE702*
7.4 kW – 1 x T2 – RFID	EVP2PE702R
7.4 kW – 1 x T2 with shutters	EVP2PE704
7.4 kW – 1 x T2 with shutters – RFID	EVP2PE704R
7.4 kW – 2 x T2	EVP2PE722
7.4 kW – 2 x T2 – RFID	EVP2PE722R*
7.4 kW – 2 x T2 with shutters	EVP2PE744*
7.4 kW – 2 x T2 with shutters – RFID	EVP2PE744R*
7.4 / 2.3 kW – T2/TF	EVP2PE72F
7.4 / 2.3 kW – T2/TF – RFID	EVP2PE72FR
7.4 / 2.3 kW – T2 with shutters/TE	EVP2PE74E
7.4 / 2.3 kW – T2 with shutters/TE – RFID	EVP2PE74ER
22.1 kW – 1 x T2	EVP2PE2202
22.1 kW – 1 x T2 – RFID	EVP2PE2202R
22.1 kW – 1 x T2 with shutters	EVP2PE2204*
22.1 kW – 1 x T2 with shutters – RFID	EVP2PE2204R*
22.1 kW – 2 x T2	EVP2PE2222*
22.1 kW – 2 x T2 – RFID	EVP2PE2222R*
22.1 kW – 2 x T2 with shutters	EVP2PE2244*
22.1 kW – 2 x T2 with shutters – RFID	EVP2PE2244R*
22.1 / 2.3 kW – T2/TF	EVP2PE222F
22.1 / 2.3 kW – T2/TF – RFID	EVP2PE222FR*
22.1 / 2.3 kW – T2 with shutters/TE	EVP2PE224E*
22.1 / 2.3 kW – T2 with shutters/TE – RFID	EVP2PE224ER
Base	
Floor-standing base	EVP2FB5
Wall-mounted base	EVP1WBS
Cap	
Floor standing	EVP2FCG
Wall mounted	EVP2WCG
Socket outlet	
Green socket outlet T2	EVP1PSS2
Green socket outlet T2S	EVP1PSS4
Green socket outlet TE	EVP1PSSE
Green socket outlet TF	EVP1PSSF
Flap	
Green scooter Flap	EVP1PSS

* Shorter delivery time

Additional offer

EVlink Management Services components	References
EVlink GPRS Modem	EVP1MM
GPRS/3G modem	EVP2MM*
GPRS/3G modem antenna for EVlink Parking	EVP2MP*
Test tool	Reference
Electric vehicle simulation tool	NCA93100

* Available september 2017

EVlink

Cable

EVlink Cable		References
32 A -T1 T2 - 5 m	1 phase	EVP1CNS32121
32 A -T1 T2 - 7 m	1 phase	EVP1CNL32121*
32 A -T2 T2 - 5 m	1 phase	EVP1CNS32122
32 A -T2 T2 - 7 m	1 phase	EVP1CNL32122*
32 A -T2 T2 - 5 m	3 phases	EVP1CNS32322
32 A -T3 T2 - 7 m	3 phases	EVP1CNL32322*
32 A -T2 T3 - 5 m	1 phase	EVP1CNS32132
32 A -T2 T3 - 5 m	3 phases	EVP1CNS32332

* Available september 2017

Life Is On

Schneider
Electric

Schneider Electric Industries SAS

35, rue Joseph Monier
CS 30323
92506 Rueil Malmaison Cedex
France

RCS Nanterre 954 503 439
Capital social 896 313 776 €
www.schneider-electric.com

April, 2017
Document Number COM-POWER-VE-CA3-EN.indd

© 2017 - Schneider Electric. All Rights Reserved.
All trademarks are owned by Schneider Electric Industries SAS or its affiliated companies.

This document has been
printed on recycled paper

